

## Dräger X-am<sup>®</sup> 5600

approved as type MQG 01\*\*

Multi-Gas Monitor

Technical Handbook



# Content

<b>For Your Safety</b> .....	<b>4</b>
<b>Intended Use</b> .....	<b>4</b>
<b>Tests and Approvals</b> .....	<b>5</b>
Intended operating area and operating conditions .....	5
Safety instructions .....	6
<b>What is What</b> .....	<b>7</b>
Front panel .....	7
Rear panel .....	7
Display .....	7
Special symbols .....	8
<b>Configuration</b> .....	<b>9</b>
Standard gas configuration .....	9
Standard instrument configuration .....	11
<b>Operation</b> .....	<b>13</b>
Preparations for operation .....	13
Switching on the instrument .....	13
Switching off the instrument .....	14
Before entering the workplace .....	14
During operation .....	15
Calling the Info Mode .....	16
Calling the Info-Off Mode .....	16
Calling the Quick Menu .....	17
Possible functions of the quick menu .....	17
Quick menu "Delete peak values" .....	18
Calling the Calibration Menu .....	19
Calibration menu functions .....	19
<b>Identifying Alarms</b> .....	<b>20</b>
Concentration pre-alarm A1 .....	20
Concentration main alarm A2 .....	20
STEL / TWA exposure alarm .....	21
Battery pre-alarm .....	21
Battery main alarm .....	21
Instrument alarm .....	21
<b>Operation with pump</b> .....	<b>22</b>
<b>Configuring the Instrument</b> .....	<b>25</b>
Testing the parameters .....	27
<b>Read Database and Display Graphically</b> .....	<b>28</b>
<b>Faults, Cause and Remedy</b> .....	<b>29</b>
Warning messages .....	29

Fault messages .....	33
<b>Maintenance .....</b>	<b>39</b>
Maintenance intervals .....	39
H <sub>2</sub> added signal .....	40
ToxicTwins .....	41
CO H <sub>2</sub> compensation .....	41
Carry out manual bump test .....	42
Manual implementation without the documentation of results in the instrument memory .....	42
Menu implementation with the documentation of results in the instrument memory .....	44
Automatic implementation with the Bump Test Station .....	46
Calibrating/adjusting the instrument .....	48
Carrying out the fresh air calibration/zero-point calibration .....	49
Carrying out 1-button calibration/adjustment .....	51
Calibrating/adjusting the sensitivity for an individual measuring channel .....	54
Example 1: Span calibration for the Ex channel of the infrared sensor .....	56
Example 2: Calibration routine for the CO <sub>2</sub> channel of the infrared sensor .....	57
Replacing the batteries / rechargeable batteries .....	59
Charging the rechargeable batteries .....	60
Charging with the multiple charging station .....	60
Charging with charging module and plug-in power pack or vehicle charging adapter .....	62
<b>Replacing the Sensors .....</b>	<b>63</b>
<b>Cleaning .....</b>	<b>65</b>
<b>Storage .....</b>	<b>65</b>
<b>Disposal .....</b>	<b>65</b>
<b>Technical Data .....</b>	<b>66</b>
<b>Order List .....</b>	<b>68</b>
Accessories .....	69
Spare parts .....	71



## For Your Safety

### General safety statements

- Before using this product, carefully read the associated Instructions for Use. This document does not replace the Instructions for Use.

### Definitions of alert icons

The following alert icons are used in this document to provide and highlight areas of the associated text that require a greater awareness by the user. A definition of the meaning of each icon is as follows:

 <b>WARNING</b>
Indicates a potentially hazardous situation which, if not avoided, could result in death or serious injury.
 <b>CAUTION</b>
Indicates a potentially hazardous situation which, if not avoided, could result in physical injury, or damage to the product or environment. It may also be used to alert against unsafe practices.
<b>NOTICE</b>
Indicates additional information on how to use the product.

## Intended Use

Portable gas detection instrument for the continuous monitoring of the concentration of several gases in the ambient air within the working area and in explosion-hazard areas.

**X-am 5600**, depending on the instrument type and configuration of DrägerSensors: independent measurement of one up to six gases.

## Tests and Approvals

Copies of the name plate and the declaration of conformity are provided in the enclosed supplementary documentation (order no. 90 33 890).

The BVS 10 ATEX E 080 X technical suitability test is based on the adjustment with the target gas.

Do not stick anything on the name plate on the gas detector.

The technical suitability tests are valid for the X-am 5600 gas detector and the calibration cradle. The explosion-protection approvals are only valid for the X-am 5600 gas detector; the calibration cradle must not be used in the Ex zone.

### Intended operating area and operating conditions

#### Areas subject to explosion hazards, classified by zones (MQG 01\*\*)

The instrument is intended for the use in explosion-hazard areas of Zone 0, Zone 1 or Zone 2 or in mines at risk due to fire damp. It is intended for use within a temperature range of  $-20\text{ }^{\circ}\text{C}$  to  $+50\text{ }^{\circ}\text{C}$ , and for areas in which gases of explosion groups IIA, IIB or IIC and temperature class T3 or T4 (depending on the batteries and rechargeable battery) may be present. If used in mines, the instrument is only to be used in areas known to have a low risk of mechanical impact.

#### Areas subject to explosion hazards, classified by divisions

The instrument is intended for use in explosion-hazard areas according to Class I&II, Div. 1 or Div. 2 within a temperature range of  $-20\text{ }^{\circ}\text{C}$  to  $+50\text{ }^{\circ}\text{C}$ , and for areas where gases or dusts of groups A, B, C, D, E, F, G and temperature class T3 or T4 may be present (depending on the rechargeable battery and batteries).

It is intended for use in a temperature range

**when using power pack ABT 0100:**

of  $-20\text{ }^{\circ}\text{C}$  to  $+50\text{ }^{\circ}\text{C}$  or  $-20\text{ }^{\circ}\text{C}$  to  $+40\text{ }^{\circ}\text{C}$  depending on the batteries used

**when using power pack HBT 0000/HBT 0100:**

from  $-20\text{ }^{\circ}\text{C}$  to  $+50\text{ }^{\circ}\text{C}$

and for gases of temperature class T3 or T4 (depending on the batteries and rechargeable battery).

#### For applications in accordance with CSA (Canadian Standards Association), the following should be observed:

Only the performance of the detector part of this instrument for flammable gases has been tested. The instrument has not been approved for use in mines by the CSA.

#### **WARNING**

Only applicable to Class II certification. CSA Std. C22.2 No 152 does not have any requirement for Class II hazardous locations and therefore this device has not been performance tested by CSA for Class II. The sensor may become clogged and not detect gas properly or warn the user of its inability to detect gas.

## Safety instructions

**⚠ WARNING**

To reduce the danger of explosion, do not mix new batteries with old batteries and do not mix batteries made by different manufacturers.

**⚠ WARNING**

Always disconnect the instrument from the power pack before carrying out any maintenance operations.

**⚠ WARNING**

Substitution of components may impair intrinsic safety.

**⚠ CAUTION**

Not tested in an oxygen-enriched atmosphere ( $>21\% \text{ O}_2$ ).

**⚠ CAUTION**

Only the combustible gas detection portion of this instrument has been assessed by CSA for performance. The instrument is not classified by CSA for use in mines.

**⚠ WARNING**

CSA requirement: A sensitivity test should be conducted before each use at a concentration between 25 and 50 % of the maximum concentration of the measured gas. The accuracy here must be between 0 and +20 % of the actual value. The accuracy can be corrected via calibration.

**⚠ WARNING**

High off-scale readings may indicate an explosive concentration.

**⚠ WARNING**

Only use power packs ABT 0100 (83 22 237), HBT 0000 (83 18 704) or HBT 0100 (83 22 244). See marking on power pack for approved batteries and related temperature class.

**⚠ WARNING**

Increased hydrogen concentrations within the measuring range of the Dräger Sensor XXS H2 HC may result in false alarms due to the additive effect on the Dräger sensors XXS H2S, and XXS CO, XXS H2S (LC) and XXS CO (LC) as well as due to the negative effect on the Dräger Sensor XXS O2.

# What is What

## Front panel

- 1 Gas entry
- 2 Alarm LED
- 3 Buzzer
- 4 OK key
- 5 + key
- 6 Display

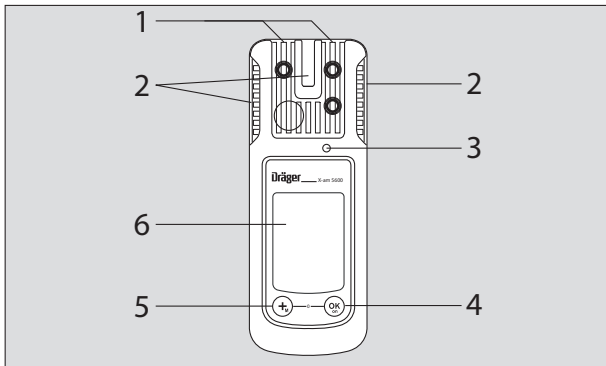

0033072\_01.eps

## Rear panel

- 1 IR interface
- 2 Fastening clip
- 3 Type plate
- 4 Charging contacts
- 5 Power pack
- 6 Serial no.

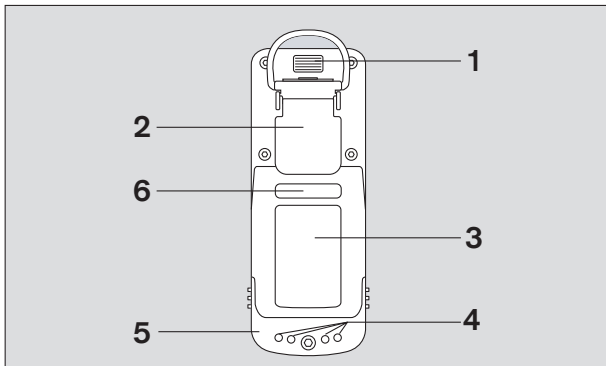

0033072\_01.eps

## Display

for 1 to 4 measuring channels:

- 1 Measured gas display
- 2 Measured gas display with unit
- 3 Special symbols

for 5 and 6 measuring channels:



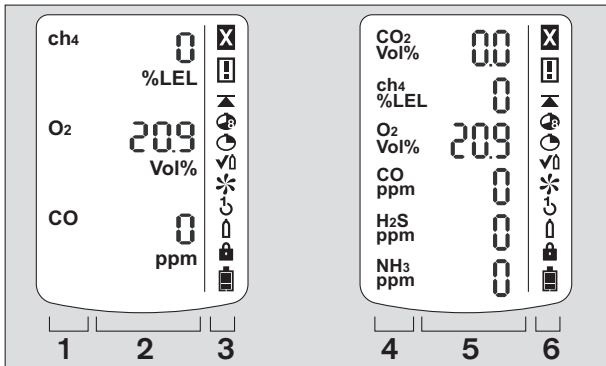











- 4 Measured gas display with unit
- 5 Measured gas display
- 6 Special symbols



0033072\_01.eps

The following only shows the instrument version with 6 measuring channels.

## Special symbols

-  Fault message, refer to Page 16
-  Warning message, refer to Page 16
-  The peak value display for all measuring gases, refer to Page 16
-  The exposure evaluation display (TWA) for measuring gases, e.g., H<sub>2</sub>S and CO, refer to Page 16
-  The exposure evaluation display (STEL) for measuring gases, e.g., H<sub>2</sub>S and CO, refer to Page 16
-  The instrument is set to function test with gas (bump test), refer to Page 42
-  The instrument is set to the fresh air calibration function, refer to Page 49
-  The instrument is set to the 1-button calibration/adjustment function, refer to Page 51
-  The instrument is set to the single gas calibration function, refer to Page 54
-  The function for password entry is active, refer to Page 19
-  Battery / rechargeable battery 100 % full
-  Battery / rechargeable battery 2/3 full
-  Battery / rechargeable battery 1/3 full
-  Battery / rechargeable battery empty

Marking offset channels:

<b>Feature</b>	<b>Reading on the display</b>
ToxicTwins	HCN+
CO H <sub>2</sub> compensation	CO+
H <sub>2</sub> offsetting	ch <sub>4</sub> +



# Configuration

## Standard gas configuration

DrägerSensor	Measuring range <sup>1)</sup>	Alarm A1 <sup>1)</sup>			Alarm A2 <sup>1)</sup>		
		threshold	can be acknowledged	self-latching	threshold	can be acknowledged	self-latching
IR Ex/CO <sub>2</sub> : IR-Ex [%LEL] IR-CO <sub>2</sub> [vol. %]	0 to 100 0 to 5	20 0.5	Yes Yes	No No	40 1.0	No No	Yes Yes
IR-Ex [%LEL]	0 to 100	20	Yes	No	40	No	Yes
IR-CO <sub>2</sub> [vol. %]	0 to 5	0.5	Yes	No	1.0	No	Yes
XXS O <sub>2</sub> [vol. %]	0 to 25	19 <sup>2)</sup>	No	Yes	23	No	Yes
XXS O <sub>2</sub> 100 [vol. %]	0 to 100	18 <sup>2)</sup>	No	Yes	24	No	Yes
XXS O <sub>2</sub> LS/CO-LC [vol.-%], [ppm]	0 to 25 O <sub>2</sub> 0 to 2000 CO	19 O <sub>2</sub> 30 CO	No Yes	Yes No	23 O <sub>2</sub> 60 CO	No No	Yes Yes
XXS O <sub>2</sub> / H <sub>2</sub> S-LC [vol%], [ppm]	0 to 25 O <sub>2</sub> 0 to 100 H <sub>2</sub> S	19 O <sub>2</sub> 5 H <sub>2</sub> S	No Yes	Yes No	23 O <sub>2</sub> 10 H <sub>2</sub> S	No No	Yes Yes
XXS CO [ppm]	0 to 2000	30	Yes	No	60	No	Yes
XXS CO LC [ppm]	0 to 2000	30	Yes	No	60	No	Yes
XXS CO-LC/H <sub>2</sub> S-LC [ppm]	0 to 2000 CO 0 to 100 H <sub>2</sub> S	30 CO 5 H <sub>2</sub> S	Yes Yes	No No	60 CO 10 H <sub>2</sub> S	No No	Yes Yes
XXS CO-LC/O <sub>2</sub> [ppm], [vol.-%]	0 to 2000 CO 0 to 25 O <sub>2</sub>	30 CO 19 O <sub>2</sub>	Yes No	No Yes	60 CO 23 O <sub>2</sub>	No No	Yes Yes
XXS CO HC [ppm]	0 to 10,000	600	Yes	No	1.200	No	Yes
XXS CO H <sub>2</sub> -CP [ppm]	0 to 2,000	30	Yes	No	60	No	Yes
XXS H <sub>2</sub> [ppm]	0 to 2,000	200	Yes	No	400	No	Yes
XXS H <sub>2</sub> S [ppm]	0 to 200	5	Yes	No	10	No	Yes
XXS H <sub>2</sub> S LC [ppm]	0 to 100	5	Yes	No	10	No	Yes
XXS H <sub>2</sub> S HC [ppm]	0 to 1,000	10	Yes	No	20	No	Yes
XXS H <sub>2</sub> S/CO [ppm]	0 to 200 H <sub>2</sub> S 0 to 2,000 CO	5 H <sub>2</sub> S 30 CO	Yes	No	10 H <sub>2</sub> S 60 CO	No	Yes
XXS H <sub>2</sub> S-LC/CO-LC [ppm]	0 to 100 H <sub>2</sub> S 0 to 2000 CO	5 H <sub>2</sub> S 30 CO	Yes Yes	No No	10 H <sub>2</sub> S 60 CO	No No	Yes Yes
XXS NO [ppm]	0 to 200	25	Yes	No	50	No	Yes
XXS NO <sub>2</sub> [ppm]	0 to 50	5	Yes	No	10	No	Yes
XXS SO <sub>2</sub> [ppm]	0 to 100	0,5	Yes	No	1	No	Yes
XXS PH <sub>3</sub> [ppm]	0 to 20	0.1	Yes	No	0.2	No	Yes
XXS PH <sub>3</sub> HC [ppm]	0 to 1,000	5	Yes	No	10	No	Yes
XXS HCN [ppm]	0 to 50	1,9	Yes	No	3,8	No	Yes
XXS HCN PC [ppm]	0 to 50	5	Yes	No	10	Yes	No
XXS NH <sub>3</sub> [ppm]	0 to 300	20	Yes	No	40	No	Yes
XXS CO <sub>2</sub> [vol. %]	0 to 5	0.5	Yes	No	1	No	Yes
XXS Cl <sub>2</sub> [ppm]	0 to 20	0.5	Yes	No	1	No	Yes
XXS H <sub>2</sub> HC [vol. %]	0 to 4	0.8	Yes	No	1.6	No	Yes

DrägerSensor	Measuring range <sup>1)</sup>	Alarm A1 <sup>1)</sup>			Alarm A2 <sup>1)</sup>		
		threshold	can be acknowledged	self-latching	threshold	can be acknowledged	self-latching
<b>XXS OV [ppm]</b>	0 to 50	10	Yes	No	20	No	Yes
<b>XXS OV A [ppm]</b>	0 to 50	10	Yes	No	20	No	Yes
<b>XXS Odorant [ppm]</b>	0 to 40	10	Yes	No	20	No	Yes
<b>XXS Amine [ppm]</b>	0 to 100	10	Yes	No	20	No	Yes
<b>XXS COCl<sub>2</sub> [ppm]</b>	0 to 10	0,1	Yes	No	0,2	No	Yes
<b>XXS O<sub>3</sub> [ppm]</b>	0 to 10	0,1	Yes	No	0,2	Yes	No
<b>XXS NO<sub>2</sub> LC [ppm]</b>	0 to 50	0,5	Yes	No	1,0	Yes	No

1) Different settings can be selected to meet customer requirements on delivery. The current setting can be checked and changed with the Dräger CC Vision software.

2) In the case of O<sub>2</sub> A1 is the lower alarm threshold: an alarm is triggered if the value is too low.

The following infrared sensors can be plugged into the gas detection instrument:

- DrägerSensor Dual IR Ex/CO<sub>2</sub> (order no. 6811960)
- DrägerSensor IR Ex (order no. 6812180)
- DrägerSensor IR CO<sub>2</sub> (order no. 6812190)
- DrägerSensor Dual IR Ex/CO<sub>2</sub> ES (order no. 6851880)
- DrägerSensor IR Ex ES (order no. 6851881)
- DrägerSensor IR CO<sub>2</sub> ES (order no. 6851882)

To simplify matters, this document generally refers to gases (e.g. Ex/CO<sub>2</sub> or IR Ex). This refers to all existing sensor types.

## Standard instrument configuration

Dräger X-am 5600 <sup>1)</sup>	
Bump test mode <sup>2)</sup>	Extended bump test
Fresh air calibration <sup>2) 3)</sup>	On
Hydrogen offset <sup>4)</sup>	On
Operating signal <sup>2) 5)</sup>	On
Capture range	On
Switch off <sup>2)</sup>	blocked at A2
LEL factor <sup>2)</sup> CH <sub>4</sub> H <sub>2</sub>	4.4 vol. % (4.4 vol. % corresponds to 100 %LEL) 4.0 vol. % (4.0 vol. % corresponds to 100 %LEL)
STEL <sup>2) 6) 7)</sup> (short-term average)	STEL function - disabled Average value duration = 15 minutes
TWA <sup>2) 7) 8)</sup> (shift average)	TWA function - disabled Average value duration = 8 hours
Alarm A1 <sup>9)</sup>	can be acknowledged, non-latching, pre-alarm, rising flank
Alarm A1 at O <sub>2</sub> sensor <sup>9)</sup>	cannot be acknowledged, latching, like main alarm, falling flank
Alarm A2 <sup>9)</sup>	cannot be acknowledged, latching, main alarm, rising flank

- 1) X-am<sup>®</sup> is a registered trademark of Dräger.
- 2) Different settings can be selected by the customer on delivery. The current setting can be checked and changed with the Dräger CC Vision software.
- 3) The fresh-gas adjustment/zero-point adjustment is not supported by the CO<sub>2</sub> channel of the infrared sensor and the XXS O<sub>3</sub>.
- 4) In the case of activated XXS H<sub>2</sub> HC and activated Ex channel in the infrared sensor.
- 5) A periodic short flashing indicates the operating capacity of the instrument. If there is no operating signal, correct operation cannot be guaranteed.
- 6) STEL: average value of an exposure over a short period, generally 15 minutes.
- 7) Interpretation only if the sensor is designed for this.
- 8) TWA: shift averages are workplace limit values for generally eight hours per day of exposure for five days a week during a working life.
- 9) Latching and acknowledgement of alarms A1 and A2 can be configured with the Dräger CC Vision PC software.

Activation of the H<sub>2</sub> offset adds the LEL gas concentration of the activated XXS H<sub>2</sub> HC to the LEL gas concentration of the activated Ex channel of the infrared sensor and it is output to the display instead of the IR Ex display.

**NOTICE**

Previously set alarm thresholds are preserved so that in the presence of hydrogen (H<sub>2</sub>) the alarm of the IR Ex channel could be triggered earlier.

Changing the configuration: see “Configuring the Instrument” on Page 25.

**⚠ WARNING**

After a basic initialization has been carried out with the PC software Dräger CC Vision, individual alarm settings may have been changed.

**Selecting or disabling the capture ranges (only applies for the measuring mode):**

The capture range is selected in the measuring mode (factory setting) and permanently disabled in calibration mode.

The CC-Vision PC software can be used to select or disable the capture ranges for the measuring mode.

# Operation

## Preparations for operation

- Before using the instrument for the first time, insert a charged NiMH T4 power pack or batteries approved by Dräger, see "Changing the batteries" on Page 59.
- The instrument is now ready for operation.







### WARNING:

To reduce the risk of ignition of a flammable or explosive atmosphere, strictly adhere to the following warning statements:

Only use power pack types ABT 01xx, HBT 00xx or HBT 01xx. See the marking on the rechargeable battery for permitted rechargeable batteries and the corresponding temperature class.



Substitution of components may impair intrinsic safety.

## Switching on the instrument

- Press and hold the  key for approx. 3 seconds until the countdown » 3 . 2 . 1 « shown in the display has elapsed.
  - All the display segments, including the visual, audible and vibration alarms, are activated for a short time.
  - The software version is displayed.
  - The instrument performs a self test.
  - The next sensor which is next due for calibration is displayed with the days remaining until the next calibration/adjustment, e.g., » **ch<sub>4</sub> %LEL CAL 123** «.
  - The time until the bump test interval elapses is displayed in days, e.g., » **bt 2** «.
  - All A1 and A2 alarm thresholds and if applicable »  « (TWA)<sup>1)</sup> and »  « (STEL)<sup>1)</sup> for all toxic gases (e. g. H<sub>2</sub>S or CO) are displayed consecutively.
  - During the sensor warm-up phase:
    - The display for the measured value flashes
    - The special symbol »  « is displayed.
    - No alarms are issued during the warm-up phase.
    - The red LEDs flash.
    - The gas detector is ready to measure when the measured values no longer flash and the red LEDs are no longer illuminated. The special symbol »  « may continue to be displayed if corresponding warnings (e.g. not yet ready for calibration) are active (to view the warnings, see the technical manual).
-  Press the key to cancel the display of the activation sequence.

1) Only when activated in the instrument configuration. Delivery condition: not activated.

## Switching off the instrument

- Press and hold the  key and  key at the same time until the countdown » 3 . 2 . 1 « shown in the display has elapsed.
- Before the instrument is switched off, the visual, audible and vibration alarms are activated for a short time.

## Before entering the workplace

### WARNING





Before any measurements relevant to safety are made, check the adjustment with a bump test, adjust if necessary and check all alarm elements. If national regulations apply, a bump test must be performed according to the national regulations. Faulty adjustment may result in incorrect measuring results, with possible serious consequences.

### WARNING



In an oxygen enriched atmosphere (>21 vol. % O<sub>2</sub>), the explosion protection cannot be guaranteed; remove instrument from the Ex area.

### NOTICE

If the gas detector is used for offshore applications, a distance of 5 m to a compass must be complied with.

- Switch on the instrument. The current measured values are shown in the display.
  - Observe any warning »  « or fault messages »  «.
    -  The instrument can be operated normally. If the warning message does not go out automatically during operation, the instrument must be maintained after the end of use.
    -  The instrument is not ready to measure and requires maintenance.
- If one of these special symbols is displayed, appropriate measures, refer to Page 29 to Page 33, must be taken.
- Check that the gas inlet opening on the instrument is not covered and/or dirty.

## During operation

- During operation, the measured values for every measured gas are displayed.
- In the event of an alarm, the corresponding displays, including the visual, audible and vibration alarms, are activated. See section "Identifying Alarms"
- If a measuring range is exceeded or not reached, the following displays are shown instead of the measured value display:
  - »  « (measuring range exceeded) or
  - »  « (measuring range not reached).
- After the measuring range of the TOX measuring channels has been exceeded temporarily (up to one hour), checking the measuring channels is not necessary.
- Following an extreme impact load, the display for the Ex- and the CO<sub>2</sub> measuring range of the IR Sensor must be checked and adjusted with zero gas and span gas if necessary.

### **NOTICE**

Special states in which there is no measuring operation (quick menu, calibration menu, warm-up of sensors, password input) are indicated by a visual signal (slow flashing of the alarm LED .

### **▲ WARNING**

When using an IR Sensor in the Dräger X-am 5600, the zero point and sensitivity must be adjusted after an impact load that causes a display other than zero for the IR sensor when the instrument is at fresh air.

## Calling the Info Mode

- In measuring mode, press the  key for approx. 3 seconds.

If any warning or fault messages exist, the corresponding information or error codes are displayed (Page 29 to Page 36).

Press the  key successively for the next display.

The peak values and the exposition values TWA<sup>1)</sup> and STEL<sup>1)</sup> are displayed.



Warning messages are displayed. Numerical codes of warning messages: see Page 29.

 key



Fault messages are displayed. Numerical codes of fault messages: see Page 33.

 key



The peak values = the maximum measured values in the case of, e.g., CO, H<sub>2</sub>S, ... or the minimum measured values in the case of O<sub>2</sub> within the storage interval are displayed

 key



The average values of the exposures based on a shift of, e.g., 8 hours (TWA) of all the active sensors for the exposure evaluation are displayed

 key



The short-term values (STEL) = average values of the concentrations over the average value duration of all the active sensors for the exposure evaluation are displayed

 key

The instrument is in measuring mode again

- If no key is pressed for 10 seconds, the instrument returns automatically to measuring mode.

## Calling the Info-Off Mode

When the instrument is in a deactivated state, press the  key.

The name of the gas, measuring unit and measuring range limit value are displayed for all channels.

Pressing the  key again exits the Info Off mode (or via timeout).

---





1) Only when activated in the instrument configuration. Delivery status: not activated.



## Calling the Quick Menu

- Only the fresh air calibration/zero-point calibration is activated in the quick menu on delivery. The PC software Dräger CC Vision can be used to activate the bump test for the quick menu and/or the function for displaying and deleting peak values.
- In measuring mode, press the  $\oplus$  key three times.  
If no functions have been activated in the quick menu, the instrument remains in measuring mode.
- You can select the activated functions of the quick menu by pressing the  $\oplus$  key.
- Press the  $\otimes$  key to call the selected function.

### Possible functions of the quick menu

-  Function test with gas (bump test), refer to Page 42.
-  Fresh air calibration, refer to Page 49. <sup>1)</sup>
-  Delete peak values, refer to Page 18.
-  Display pump information, refer to Page 22.
-  Activate or deactivate pump, refer to Page 22.
- Press the  $\oplus$  key to cancel the active function and to switch to measuring mode.
- If no key is pressed for 60 seconds, the instrument returns automatically to measuring mode.

1) The fresh-gas adjustment/zero-point adjustment is not supported by the CO<sub>2</sub> channel of the infrared sensor and the XXS O<sub>3</sub>. A zero-point calibration / adjustment of these sensors can be conducted using the Dräger CC-Vision PC software. To do so, a suitable zero gas that is free of carbon dioxide and ozone (e.g. N<sub>2</sub>) should be used.

## Quick menu "Delete peak values"

After the function has been selected, the current peak values are displayed; the peak values special symbol appears in the display at the same time.

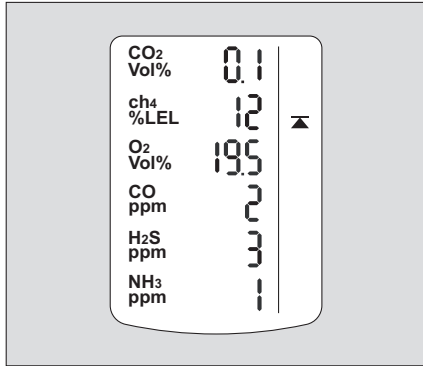

- The peak values can be deleted by pressing the  key for 5 sec. The adjacent display appears.

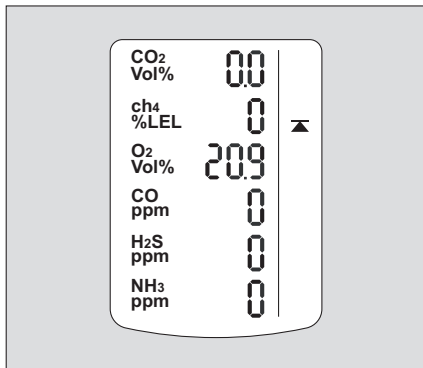

- Press the  key to end the function.

## Calling the Calibration Menu

- The calibration menu can only be accessed by entering a password.  
Password on delivery: » **001** «
- The default password on delivery can be changed using the PC software Dräger CCVision.
- In measuring mode, press the **+** key for at least 4 seconds.
- The function for entering the password is selected.
- The special symbol » **🔒** « (for the "enter password" function) is displayed.
- The display shows » **000** «, with the first digit flashing.
- Use the **+** key to set the flashing digit.
- Press the **OK** key, the second digit starts flashing.
- Use the **+** key to set the flashing digit.
- Press the **OK** key, the third digit starts flashing.
- Use the **+** key to set the flashing digit.
- Press the **OK** key, the password once it has been set completely.
- The calibration menu functions can now be selected by pressing the **+** key.
- Press the **OK** key to call the selected function.

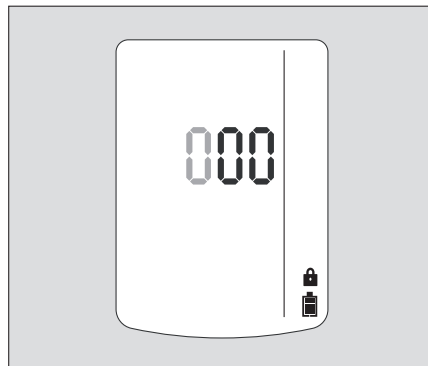

02538072\_01.rpps

### Calibration menu functions

- \*** Fresh air calibration, refer to Page 49. <sup>1)</sup>
- 1** 1-button calibration/adjustment, refer to Page 51.
- 🔑** Single gas calibration/adjustment, refer to Page 54.

- Press the **+** key to cancel the active function.
- If no key is pressed for 10 minutes, the instrument automatically returns to measuring mode.

1) The fresh-gas adjustment/zero-point adjustment is not supported by the CO<sub>2</sub> channel of the infrared sensor and the XXS O<sub>3</sub>. A zero-point calibration / adjustment of these sensors can be conducted using the Dräger CC-Vision PC software. To do so, a suitable zero gas that is free of carbon dioxide and ozone (e.g. N<sub>2</sub>) should be used.

## Identifying Alarms

An alarm is displayed visually, audibly and through vibration in a specific pattern.

### NOTICE

At low temperatures the legibility of the display can be improved by switching on the backlight.

### Concentration pre-alarm A1

The alarm is indicated by an intermittent alarm message:



Display » **A1** « and measured value alternating: not for O<sub>2</sub>!

- The pre-alarm A1 is not self-latching and stops when the concentration has dropped below the alarm threshold A1.
- In the case of A1 a single tone is audible and the alarm LED flashes.

Acknowledging the pre-alarm:

- Press the  key. Only the audible alarm and the vibration alarm are switched off.

### Concentration main alarm A2

The alarm is indicated by an intermittent alarm message:



Display » **A2** « and measured value alternating:

In the case of A2 a double tone is audible and the alarm LED flashes twice.

For O<sub>2</sub>: » **A1** « and measured value alternating = oxygen deficiency  
» **A2** « and measured value alternating = oxygen surplus

### WARNING

Danger to life! Leave the area immediately. A main alarm is self-latching and cannot be acknowledged or cancelled.

After leaving the area, if the concentration is less than the alarm threshold A2:



- Press the  key. The alarm messages are switched off.

### WARNING

The measuring range 0 to 100 vol. % CH<sub>4</sub> is not suitable for monitoring explosive mixtures in the measuring range of 0 to 100 %LEL.

## STEL / TWA exposure alarm

The alarm is indicated by an intermittent alarm message: 

Display » **A2** « and »  « (TWA) or »  « (STEL) and measured value alternating:

 <b>WARNING</b>
Risk to health! Leave the area immediately. After this alarm, the deployment of personnel is subject to the relevant national regulations.

<b>NOTICE</b>
The STEL alarm can be triggered with a maximum delay of one minute.

- STEL and TWA alarms cannot be acknowledged or cancelled.
- Switch off the instrument. The values for the exposure evaluation are deleted after the instrument is switched on again.

## Battery pre-alarm

The alarm is indicated by an intermittent alarm message: 

Flashing special symbol »  « on the right side of the display:

Acknowledging the pre-alarm:

- Press the  key. Only the audible alarm and the vibration alarm are switched off.
- The battery still lasts approx. 20 minutes after the first battery pre-alarm.

## Battery main alarm

The alarm is indicated by an intermittent alarm message: 

Flashing special symbol »  « on the right side of the display:

The battery main alarm cannot be acknowledged or cancelled:

- The instrument is automatically switched off again after 10 seconds.
- Before the instrument is switched off, the visual, audible and vibration alarms are activated for a short time.

## Instrument alarm

The alarm is indicated by an intermittent alarm message: 

Special symbol »  « on the right side of the display:

- The instrument or one or several sensor channels are not ready for operation.
- For remedies, refer to Page 29 to Page 36.
- If necessary, commission the Dräger Safety Service Center to eliminate the error.

## Operation with pump

### Observe the following when performing measurements using the pump

- Perform visual inspection of the probe, if necessary.
- Wait for the flushing time to end.  
Flush the Dräger sampling hose or Dräger probes prior to each measurement with the air sample to be measured.

The flushing phase is necessary to minimize or eliminate any effects associated with the use of a sampling hose or a probe, e.g. memory effects, dead volume. The duration of the flushing phase depends on factors such as type and concentration of the gas or vapour to be measured, material, length, diameter and age of the sampling hose or probe. As a rule of thumb, a typical flushing time of 3 seconds per metre can be assumed for a sampling hose (factory-new, dry, clean). This flushing time applies in addition to the sensor response time (see instructions for use of the gas detector used).

#### Example:

The flushing time for a 10 m hose is approx. 30 seconds. The sensor response time is approx. 60 seconds in addition. The overall time before reading the gas detector therefore is approx. 90 seconds.

The flow alarm is delayed by 10 to 30 seconds, depending on the hose length.

### Carrying out a measurement with the Dräger X-am pump

Required accessories (see "Accessories" on Page 69):

- Dräger X-am pump
- Sampling hose and probes

Commissioning and performing the measurement:

- See instructions for use of the Dräger X-am pump.

## Performing a measurement with the Dräger X-am Pump

Required accessories (see "Accessories" on Page 69):

- Dräger X-am Pump
- Sampling hose and probes

Pump symbols:



Pump battery 100 % charged



Warning for pump  
(Gas detector can no longer detect pump.)



Remaining charge of pump  
battery: 2/3



Leak test:  
Block suction inlet



Remaining charge of pump  
battery: 1/3



Leak test:  
Release suction inlet





Pump battery discharged

Commissioning and performing the measurement:

- See instructions for use of the Dräger X-am Pump.





Viewing pump information:

- Open the quick menu (see "Calling the Quick Menu" on Page 17).
- Select  and confirm with the  button.

The following pump information will be displayed:

- serial number
- pump runtime (current operation)
- pump battery charge
- Press the  button to return to measuring mode.

Activating or deactivating the pump:

- Open the quick menu (see "Calling the Quick Menu" on Page 17).
- Select  or  and activate or deactivate the pump by pressing the  button.
- Press the  button to return to measuring mode.

### WARNING

No measurement!

If the pump is connected but deactivated, the gas detector is not ready to measure.  
The red LEDs on the gas detector flash.

**⚠ WARNING**

**Impairment of accuracy!**

After measuring high concentrations of nonane (>20 %LEL), the accuracy for measuring nonane is impaired.

The pump is not suitable for long-term measurement of high concentrations of nonane.

**Performing a measurement with a manual pump adapter and rubber ball pump**

Required accessories (see "Accessories" on Page 69):

- Manual pump adapter
- Rubber ball pump
- Sampling hose
- Probes

Commissioning and performing the measurement:

- See instructions for use of the accessories used.



## Configuring the Instrument

To individually configure a instrument with standard configuration, the instrument must be connected with a PC.

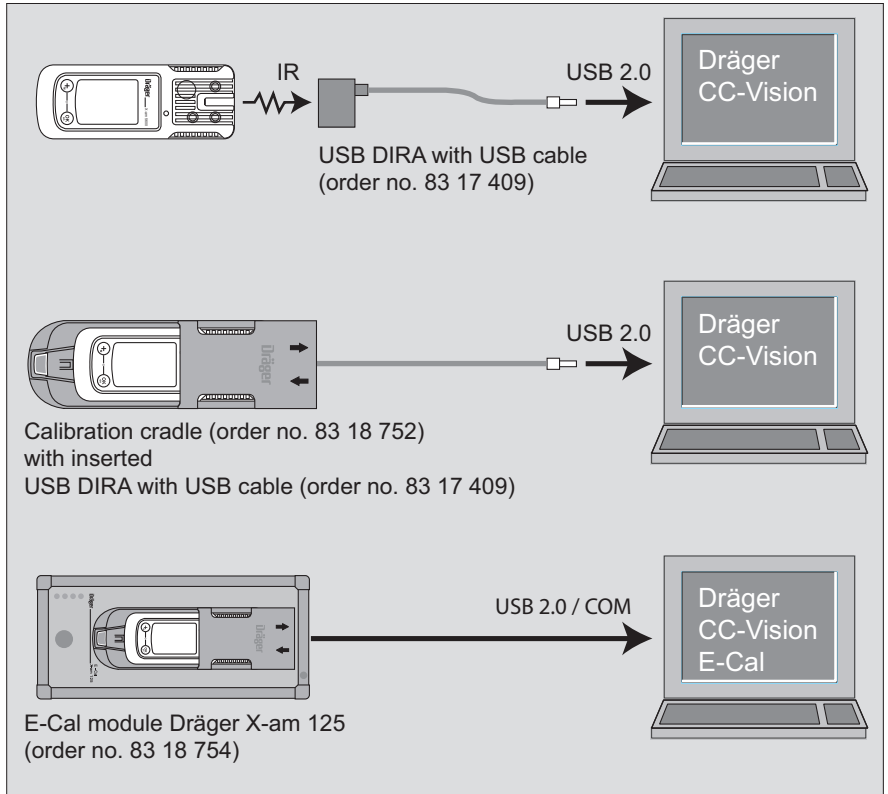

The installed PC software Dräger CC Vision is used for configuration.

- Observe the documentation and online help of the software.

**Device settings**

**NOTICE**

Only trained personnel are permitted to make changes to the device configuration.

The following changes can be made to the device parameters for a device:

<b>Designation</b>	<b>Field</b>
Password	Numeric field (3-figure)
Operating signal LED <sup>1)</sup>	Yes/No
Operating signal horn <sup>1)</sup>	Yes/No
Switch-off mode	“Switch off permitted” or “Switch off prohibited” or “Switch off prohibited at A2”
Shift length (TWA) <sup>2)</sup> (in minutes)	60 - 14400 (setting for exposure alarm)
Short-term exposure limit (STEL) <sup>3) 4)</sup> (in minutes)	0 - 15 (setting for exposure alarm)
User ID(12 characters)	Alphanumeric field
Switch database on or off	On/Off
Overwrite database	Yes/No
Database mode	Peak/Average
Database interval	1 s / 10 s / 30 s / 1 min / 2 min / 5 min / 10 min / 30 min
Date	(date on the PC)
Time	(time on the PC)
Warning after expiry of calibration interval	Yes/No
Error after expiry of calibration interval	Yes/No
Delay until error after expiry of calibration interval (days)	0 - 10
Automatic detection of Bump Test Station	Yes/No
Activate span calibration following negative bump test	Yes/No (relates only to a device connected to the Dräger Bump Test Station)
Bump test mode	“extended bump test” or “quick bump test” or “bump test deactivated”
Warning after expiry of bump test interval	Yes/No
Error after expiry of bump test interval (if warning activated)	Yes/No
Capture range	Yes / No

Remote configuration	Yes / No
Bump test interval (days)	1 - 732
Delay until error after expiry of cal. interval (days)	0 - 10
Activate user service life	Yes/No
User service life (days) (if activated)	0 - 999
Running in	Yes/No
LEL category	“---” or “PTB” or “IEC” or “NIOSH” (if this is changed, the LEL factor will be altered to match)
ToxicTwins (HCN)	Yes/No

- 1) At least one of the two operating signals must be switched on.
- 2) Corresponds to the averaging time and is used to calculate the exposure value TWA.
- 3) Only evaluated if the sensor is provided for the purpose.
- 4) Corresponds to the averaging time and is used to calculate the exposure value STEL.

### Sensor settings

The following changes can be made to the sensor parameters for the sensors:

Designation	Field
Alarm threshold A1 (in measurement unit)	0 - A2
Alarm threshold A2 (in measurement unit)	A1 – Measuring range limit value
Type of evaluation <sup>1)</sup>	Inactive, TWA, STEL, TWA+STEL
Alarm threshold STEL (in measurement unit) <sup>1)</sup>	0 – Measuring range limit value
Alarm threshold TWA (in measurement unit) <sup>1)</sup>	0 – Measuring range limit value
Calibration interval (days)	0 - 180 (sensor-dependent)
Unit (sensor-dependent)	Vol%, %UEG, %LEL, %LIE, ppm, mbar, ppb, mg/m <sup>3</sup>
Gas name: “Ex” (IR-Ex channel only)	Yes/No

- 1) Only evaluated if the sensor is provided for the purpose.

### Testing the parameters

In order to ensure that the values have been correctly transferred to the gas measuring device:

- Press the touch button **Data from X-am 1/2/5x00**
- Check parameters.

## Read Database and Display Graphically

To read the database of the instrument and display it graphically, the instrument must be connected with a PC.

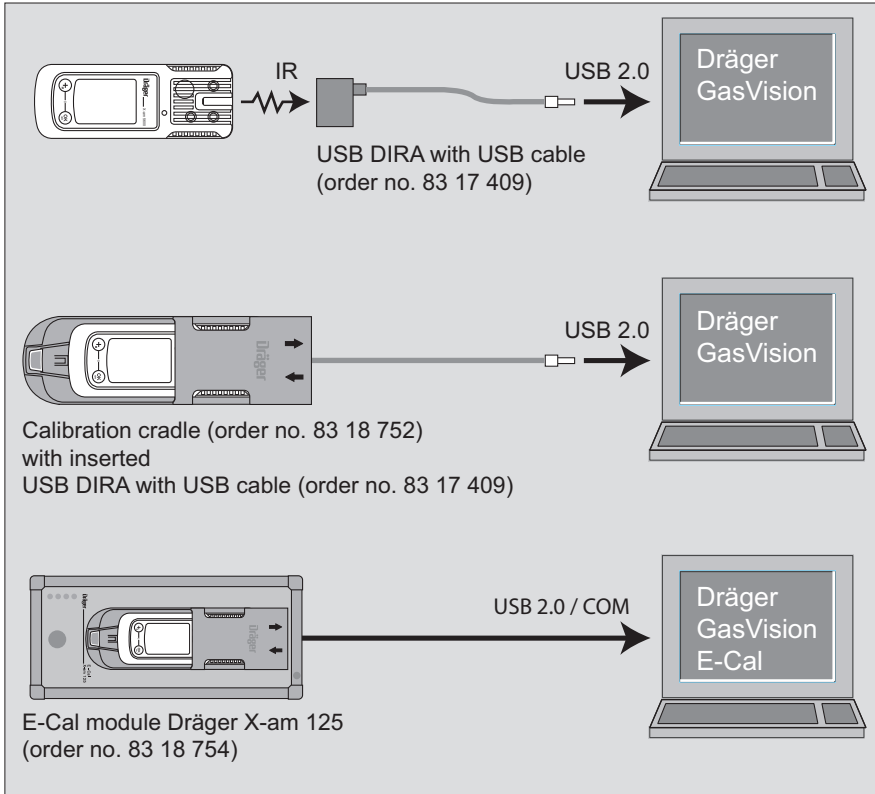

The installed PC software Dräger GasVision is used for reading and displaying the database.

- Observe the documentation and online help of the software.

## Faults, Cause and Remedy

Fault	Cause	Remedy
Not possible to switch on the instrument	Discharge the power pack	Charge the power pack, Page 60.
	Discharge the alkaline batteries	Insert new alkaline batteries, Page 59.
Not possible to switch off the instrument	The instrument is not set to measuring mode	Select measuring mode.
	The instrument is configured to "Disable prohibited"	Configure the instrument to "Disable allowed" with Dräger CC Vision.
Display » -- «	Measuring range calibrated/adjusted incorrectly	Recalibrate/adjust the measuring range, Page 48.
	Electronics or sensors defective	Must be repaired by Service.

To display the numerical codes of the warning and fault messages in the info mode, Page 16.

## Warning messages

Special symbol » ⓘ « and displayed numerical code:	Cause	Remedy
152	Customer's service life counter about to elapse'	Reset the service life counter using Dräger CC Vision.
153	Database 90 % full	Read the database soon and clear memory afterwards.
154	Database full	Read the database and clear memory.
155	Interval for the function test with gas (bump test) elapsed	Carry out the function test, Page 42.
159	Calibration/adjustment not possible. The menu function cannot be carried out because of a message which is preventing the function (e.g., sensors in warm-up phase).	Determine the message code via the info menu and switch it off, if necessary.

<b>Special symbol</b> » ⓘ « and displayed numerical code:	<b>Cause</b>	<b>Remedy</b>
<b>351</b>	DrägerSensor XXS EC1 in the warm-up phase	Wait until warm-up time is complete.
<b>352</b>	DrägerSensor XXS EC1 in the warm-up phase	Wait until warm-up time is complete.
<b>353</b>	EC1 concentration has drifted into the negative range	Carry out fresh air calibration/ zero-point calibration, Page 49.
<b>354</b>	The temperature is too high	Operate the instrument within the allowed temperature range.
<b>355</b>	The temperature is too low	Operate the instrument within the allowed temperature range.
<b>356</b>	The calibration interval for DrägerSensor XXS EC1 has elapsed	Carry out span calibration/ adjustment for DrägerSensor XXS EC1, Page 54.
<b>357</b>	Alarm setpoint A2 setting is greater than 60 %LEL	Set alarm setpoint to less than 60 %LEL.

<b>451</b>	DrägerSensor XXS EC2 in the warm-up phase	Wait until warm-up time is complete.
<b>452</b>	DrägerSensor XXS EC2 in the warm-up phase	Wait until warm-up time is complete.
<b>453</b>	EC2 concentration has drifted into the negative range	Carry out fresh air calibration/ adjustment, Page 49.
<b>454</b>	The temperature is too high	Operate the instrument within the allowed temperature range.
<b>455</b>	The temperature is too low	Operate the instrument within the allowed temperature range.
<b>456</b>	The calibration interval for DrägerSensor XXS EC2 has elapsed	Carry out span calibration for DrägerSensor XXS EC 3, Page 54.
<b>457</b>	Alarm setpoint A2 setting is greater than 60 %LEL	Set alarm setpoint to less than 60 %LEL.

<b>551</b>	DrägerSensor XXS EC3 in the warm-up phase	Wait until warm-up time is complete.
<b>552</b>	DrägerSensor XXS EC3 in the warm-up phase	Wait until warm-up time is complete.

Special symbol » ⓘ « and displayed numerical code:	Cause	Remedy
553	EC3 concentration has drifted into the negative range	Carry out fresh air calibration/ zero-point calibration, Page 49.
554	The temperature is too high	Operate the instrument within the allowed temperature range.
555	The temperature is too low	Operate the instrument within the allowed temperature range.
556	The calibration interval for DrägerSensor XXS EC3 has elapsed	Carry out span calibration for DrägerSensor XXS EC 3, Page 54.
557	Alarm setpoint A2 setting is greater than 60 %LEL	Set alarm setpoint to less than 60 %LEL.
575	Calibration interval for the compensation channel has elapsed	Adjust the sensitivity of the compensation channel.
576	Calibration required because of overgassing.	Adjust the sensitivity of the compensation channel.

651	DrägerSensor XXS EC 4 in the warm-up phase	Wait until warm-up time is complete.
652	DrägerSensor XXS EC 4 in the warm-up phase	Wait until warm-up time is complete.
653	EC 4 concentration has drifted into the negative range	Carry out fresh air calibration/ zero-point calibration, Page 49.
654	The temperature is too high	Operate the instrument within the allowed temperature range.
655	The temperature is too low	Operate the instrument within the allowed temperature range.
656	The calibration interval for DrägerSensor XXS EC 4 has elapsed	Carry out span calibration for DrägerSensor XXS EC 4, Page 54.
657	Alarm setpoint A2 setting is greater than 60 %LEL	Set alarm setpoint to less than 60 %LEL.

751	CO <sub>2</sub> channel of the infrared sensor is warming up	Wait until warm-up time is complete.
752	CO <sub>2</sub> channel of the infrared sensor is warming up	Wait until warm-up time is complete.

Special symbol » ⓘ « and displayed numerical code:	Cause	Remedy
753	Concentration of the CO <sub>2</sub> channel of the infrared sensor has drifted into the negative range	Carry out zero-point calibration, Page 49.
754	The temperature is too high	Operate the instrument within the allowed temperature range.
755	The temperature is too low	Operate the instrument within the allowed temperature range.
756	Calibration interval for the CO <sub>2</sub> channel of the infrared sensor expired	Carry out a span calibration for the CO <sub>2</sub> channel of the infrared sensor, Page 54.
781	Unstable signal of the CO <sub>2</sub> channel of the infrared sensor	The warning will reset itself once the sensor has stabilised.
782	Zero-point correction of the DrägerSensor IR CO <sub>2</sub> too high	Carry out span calibration for DrägerSensor IR CO <sub>2</sub>
851	Ex channel of the infrared sensor is warming up	Wait until warm-up time is complete.
852	Ex channel of the infrared sensor is warming up	Wait until warm-up time is complete.
853	Concentration of the Ex channel of the infrared sensor has drifted into the negative range	Carry out fresh air calibration/ zero-point calibration, Page 49.
854	The temperature is too high	Operate the instrument within the allowed temperature range.
855	The temperature is too low	Operate the instrument within the allowed temperature range.
856	Calibration interval for the Ex channel of the infrared sensor expired	Carry out a span calibration for the Ex channel of the infrared sensor, Page 54.
857	Alarm setpoint A2 setting is greater than 60 %LEL	Set alarm setpoint to less than 60 %LEL.
881	Unstable signal of the Ex channel of the infrared sensor	The warning will reset itself once the sensor has stabilised.



Special symbol » ⓘ « and displayed numerical code:	Cause	Remedy
882	Zero-point correction of the DrägerSensor Ex too high	Carry out span calibration for DrägerSensor IR Ex

### Fault messages

Special symbol » ⓘ « and displayed numerical code:	Cause	Remedy
102	The customers service lifecounter has elapsed	Reset the service life counter using Dräger CC Vision.
103	The instrument is defective	The instrument must be repaired by Service.
104	Check sum error program code	The instrument must be repaired by Service.
105	The bump test interval has elapsed	Carry out bump test, Page 46.
106	The calibration interval has elapsed (at least 1 calibration interval has elapsed)	Carry out span calibration/ adjustment, Page 51 or Page 54.
107	Bump test error (at least 1 channel has a bump test error)	Carry out bump test, Page 46 or carry out span calibration/ adjustment, Page 51 or Page 54.
108	The instrument is defective	The instrument must be repaired by Service.
109	The menu function cannot be carried out because of an error.	Determine the error code via the info menu and switch it off, if necessary.
111	Failed alarm element test: alarm light.	Repeat alarm element test with Dräger X-dock.
112	Failed alarm element test: alarm horn.	Repeat alarm element test with X-dock.
113	Failed alarm element test: Vibration motor.	Repeat alarm element test with X-dock.
114	Defective parameter check	Correct parameters and repeat test using X-dock
115	Device is disabled by X-dock.	Activate device with X-dock.
116	Failed software update.	The device must be repaired by DrägerService.

<b>Special symbol</b> » ☒ « and displayed numerical code:	<b>Cause</b>	<b>Remedy</b>
<b>117</b>	User parameters not feasible	Check configuration of user parameters and adjust
<b>118</b>	Flow alarm of X-am Pump	Check the gas circuit for obstructions and replace filters if necessary.
<b>119</b>	Battery pre-alarm of X-am Pump	Charge pump.
<b>120</b>	Battery alarm of X-am Pump	Charge pump.

<b>301</b>	The zero-point calibration/ adjustment of DrägerSensor XXS EC1 is not valid	Carry out fresh air calibration/ zero-point calibration, Page 49.
<b>302</b>	The span calibration/ adjustment of DrägerSensor XXS EC1 is not valid	Carry out span calibration, Page 54 or carry out fresh air calibration, Page 49.
<b>303</b>	The measured value of DrägerSensor XXS EC 1 is in the negative range	Carry out fresh air calibration/ zero-point calibration, Page 49.
<b>304</b>	DrägerSensor XXS EC1 is not inserted or defective	Check DrägerSensor XXS EC1, Page 63.
<b>305</b>	Error during the function test with gas (bump test) of the DrägerSensor XXS EC1	Repeat function test. Calibrate or replace DrägerSensor XXS EC1, if necessary Page 63.
<b>307</b>	Failed rise time test.	Repeat rise time test with X-dock.
<b>308</b>	User parameters not feasible	Check configuration of user parameters and adjust
<b>326</b>	Error during warm-up acceleration DrägerSensor XXS EC1	Disconnect and reconnect power pack or replace the sensor. Sensor must not be loaded with gas within the first 5 minutes.

<b>401</b>	The zero-point calibration/ adjustment of DrägerSensor XXS EC2 is not valid	Carry out fresh air calibration/ zero-point calibration, Page 49.
<b>402</b>	The span calibration/ adjustment of DrägerSensor XXS EC2 is not valid	Carry out span calibration/ adjustment, Page 54.

<b>Special symbol</b> » ☒ « and displayed numerical code:	<b>Cause</b>	<b>Remedy</b>
<b>403</b>	The measured value of DrägerSensor XXS EC 2 is in the negative range	Carry out fresh air calibration/ zero-point calibration, Page 49.
<b>404</b>	DrägerSensor XXS EC2 is not inserted or defective	Check DrägerSensor XXS EC2, Page 63.
<b>405</b>	Error during the function test with gas (bump test) of DrägerSensor XXS EC2	Repeat function test. Calibrate or replace DrägerSensor XXS EC2, if necessary Page 63.
<b>406</b>	Failed filter test.	Repeat filter test with X-dock.
<b>407</b>	Failed rise time test.	Repeat rise time test with X-dock.
<b>408</b>	User parameters not feasible	Check configuration of user parameters and adjust
<b>426</b>	Error during warm-up acceleration DrägerSensor XXS EC2	Disconnect and reconnect power pack or replace the sensor. Sensor must not be loaded with gas within the first 5 minutes.
<b>501</b>	The zero-point calibration/ adjustment of DrägerSensor XXS EC3 is not valid	Carry out fresh air calibration/ zero-point calibration, Page 49.
<b>502</b>	The span calibration/ adjustment of DrägerSensor XXS EC3 is not valid	Carry out span calibration/ adjustment, Page 54.
<b>503</b>	The measured value of DrägerSensor XXS EC3 is in the negative range	Carry out fresh air calibration/ zero-point calibration, Page 49.
<b>504</b>	DrägerSensor XXS EC3 is not inserted or defective	Check DrägerSensor XXS EC3, Page 63.
<b>505</b>	Error during the function test with gas (bump test) of the DrägerSensor XXS EC3	Repeat function test. Calibrate or replace DrägerSensor XXS EC3, if necessary Page 63.
<b>506</b>	Failed filter test.	Repeat filter test with X-dock.
<b>507</b>	Failed rise time test.	Repeat rise time test with X-dock.
<b>508</b>	User parameters not feasible	Check configuration of user parameters and adjust

Special symbol » ☒ « and displayed numerical code:	Cause	Remedy
525	The span calibration for the compensation channel is not valid	Adjust the sensitivity of the compensation channel.
526	Error during warm-up acceleration DrägerSensor XXS EC3	Disconnect and reconnect power pack or replace the sensor. Sensor must not be loaded with gas within the first 5 minutes.
601	The zero-point calibration/ adjustment of DrägerSensor XXS EC 4 is not valid	Carry out fresh air calibration/ zero-point calibration, Page 49.
602	The span calibration/ adjustment of the DrägerSensor XXS EC 4 is not valid	Carry out span calibration/ adjustment, Page 54.
603	The measured value of DrägerSensor XXS EC 4 is in the negative range	Carry out fresh air calibration/ zero-point calibration, Page 49.
604	DrägerSensor XXS EC 4 is not inserted or defective	Check DrägerSensor XXS EC 4, Page 63.
605	Error during the function test with gas (bump test) of DrägerSensor XXS EC 4	Repeat function test. Calibrate or replace DrägerSensor XXS EC 4, if necessary Page 63.
606	Failed filter test.	Repeat filter test with X-dock.
607	Failed rise time test.	Repeat rise time test with X-dock.
608	User parameters not feasible	Check configuration of user parameters and adjust
626	Error during warm-up acceleration DrägerSensor XXS EC4	Disconnect and reconnect power pack or replace the sensor. Sensor must not be loaded with gas within the first 5 minutes.
701	The zero-point calibration/ adjustment of Dräger Sensors IR CO <sub>2</sub> is not valid	Carry out zero-point calibration, Page 49.

Special symbol » ☒ « and displayed numerical code:	Cause	Remedy
702	No valid span calibration of the CO <sub>2</sub> channel of the infrared sensor	Carry out span calibration, Page 54 or carry out fresh air calibration, Page 49.
703	Measured value of the CO <sub>2</sub> channel of the infrared sensor is in the negative range	Carry out zero-point calibration, Page 49.
704	Infrared sensor (CO <sub>2</sub> channel) not plugged in	Check the CO <sub>2</sub> channel of the infrared sensor, Page 63.
705	Error during bump test of the CO <sub>2</sub> channel of the infrared sensor	Repeat the bump test; if necessary, adjust the CO <sub>2</sub> channel of the infrared sensor or replace the sensor, Page 63.
706	Failed filter test.	Repeat filter test with X-dock.
707	Failed rise time test.	Repeat rise time test with X-dock.
708	User parameters not feasible	Check configuration of user parameters and adjust
731	Error in the CO <sub>2</sub> channel of the infrared sensor	Check the CO <sub>2</sub> channel of the infrared sensor, Page 63.
732	Error in the CO <sub>2</sub> channel of the infrared sensor	Check the CO <sub>2</sub> channel of the infrared sensor, Page 63.
733	Unstable signal of the CO <sub>2</sub> channel of the infrared sensor	The error will reset itself once the sensor has stabilised.
734	Zero-point adjustment of the CO <sub>2</sub> channel of the infrared sensor failed	Repeat zero-point calibration.
735	Span calibration for the CO <sub>2</sub> channel of the infrared sensor failed	Repeat span calibration.
801	No valid zero-point adjustment of the Ex channel of the infrared sensor	Carry out fresh air calibration/ zero-point calibration, Page 49.
802	No valid span calibration of the Ex channel of the infrared sensor	Carry out span calibration, Page 54 or carry out fresh air calibration, Page 49.

Special symbol » ☒ « and displayed numerical code:	Cause	Remedy
803	Measured value of the Ex channel of the infrared sensor is in the negative range	Carry out fresh air calibration/ zero-point calibration, Page 49.
804	Infrared sensor (Ex channel) not plugged in	Check the Ex channel of the infrared sensor, Page 63.
805	Error during bump test of the Ex channel of the infrared sensor	Repeat the bump test; if necessary, adjust the Ex channel of the infrared sensor or replace the sensor, Page 63.
806	Failed filter test.	Repeat filter test with X-dock.
807	Failed rise time test.	Repeat rise time test with X-dock.
808	User parameters not feasible	Check configuration of user parameters and adjust
831	Error in the Ex channel of the infrared sensor	Check the Ex channel of the infrared sensor, Page 63.
832	Error in the Ex channel of the infrared sensor	Check the Ex channel of the infrared sensor, Page 63.
833	Unstable signal of the Ex channel of the infrared sensor	The error will reset itself once the sensor has stabilised.
834	Zero-point adjustment of the Ex channel of the infrared sensor failed	Repeat zero-point calibration.
835	Span calibration for the Ex channel of the infrared sensor failed	Repeat span calibration.

# Maintenance

## Maintenance intervals

The instrument should be inspected and maintained by suitably qualified persons annually. Comparisons:

- EN 60079-29-2 – Gas detectors - Selection, installation, use and maintenance of detectors for flammable gases and oxygen
- EN 45544-4 – Electrical apparatus used for the direct detection and direct concentration measurement of toxic gases and vapours - Part 4: Guide for selection, installation, use and maintenance
- National regulations

Recommended calibration interval for measuring channels O<sub>2</sub>, H<sub>2</sub>S, H<sub>2</sub>, SO<sub>2</sub>, NO<sub>2</sub> and CO: 6 months.

Recommended calibration interval for the measuring channel IR Ex/CO<sub>2</sub>: 12 months.

<b>NOTICE</b>
Calibration interval of other gases: see Instructions for Use for the respective Dräger sensors.

- Depending on instrument configuration:
  - Replace the alkaline batteries or charge the battery – refer to Page 59 to Page 60 – after each use, at the latest after the battery alarm has been triggered or after 2 weeks.
- Calibrating/adjusting the instrument – Page 48.
  - In regular intervals, according to the sensors used and the operating conditions. For sensor-specific calibration data, refer to the Instructions for Use/data sheets of the Dräger sensors used<sup>1)</sup>.
  - Before you carry out safety-related relevant measurements, the zero point and sensitivity of the instruments should be tested in accordance with national regulations.
- Inspection by suitably qualified persons – every year.
  - The inspection intervals must be established in each individual case and shortened if necessary, depending on technical safety considerations, engineering conditions and the technical requirements of the equipment.
  - We recommend that a service agreement be concluded with Dräger Safety and that repairs also be carried out by them.
- Replace the sensors, Page 63 – if necessary, when it is not possible to calibrate/adjust the sensors anymore.

1) See also attached instructions for use and data sheets of the sensors used. The instructions for use/data sheets of the sensors used can be downloaded at [www.draeger.com/ifu](http://www.draeger.com/ifu).

## H<sub>2</sub> added signal

 **WARNING**

After activating or deactivating the H<sub>2</sub> added signal check the set alarm thresholds.

 **WARNING**

In the case of a manual function test the effect of the H<sub>2</sub> added signal must be taken into account accordingly.

The H<sub>2</sub> offset function is only supported if an XXS H<sub>2</sub> HC is operated together with an Ex channel of the infrared sensor in the Dräger X-am 5600. Both units must be set to LEL.

An added signal can be activated and deactivated via the Dräger CC-Vision PC software.

If the H<sub>2</sub> added signal feature is activated, ch<sub>4</sub>+ appears in the measured value display.

Activation of the H<sub>2</sub> offset adds the LEL gas concentration of the activated XXS H<sub>2</sub> HC to the LEL gas concentration of the activated Ex channel of the infrared sensor and it is output to the display instead of the IR Ex display.

**NOTICE**

Maintain the set alarm thresholds as they are to ensure that in the presence of hydrogen (H<sub>2</sub>) the alarm of the IR Ex Channel is triggered earlier if required.

**NOTICE**

A potentially activated H<sub>2</sub> added signal is automatically temporarily deactivated during a manual calibration, a PC calibration or an automatic Bump Test for the relevant duration.



## ToxicTwins

When the ToxicTwins feature is activated, the measuring channels of the XXS CO sensor and the XXS HCN sensor are offset against each other in such a manner that the device issues an alarm before the respective A1 alarm threshold is reached if both gases are detected at the same time.

Prerequisites:

- The XXS CO and XXS HCN sensors are installed.
- The ToxicTwins feature is activated (using the Dräger CC-Vision PC software).

If the ToxicTwins feature is activated, HCN+ appears in the measured value display.

## CO H<sub>2</sub> compensation

Carbon monoxide (CO) and hydrogen (H<sub>2</sub>) can occur simultaneously in workplaces in the steel industry, refineries, sewage works, etc. Hydrogen affects the CO signal in ordinary commercially available sensors, which leads to false alarms. The XXS CO H<sub>2</sub>-CP sensor uses two sensing electrodes. One of these electrodes measures CO and H<sub>2</sub>, the other one measures only H<sub>2</sub>. The difference between the two signals is calculated, so that only the CO value will be displayed. For example, a hydrogen concentration of 1000 ppm (2.5 %LEL) will only result in a maximum of 15 ppm CO being displayed, but the CO alarm will not be triggered.

This feature is automatically available and activated if the XXS CO H<sub>2</sub>-CP sensor is installed. Deactivation is not possible.

Prerequisites:

- XXS CO H<sub>2</sub>-CP sensor is installed.

If this feature is used, CO+ appears in the measured value display.

## Carry out manual bump test

### ⚠ WARNING

In the case of a manual function test the effect of the H<sub>2</sub> added signal must be taken into account accordingly.

### NOTICE

A potentially activated H<sub>2</sub> added signal is automatically temporarily deactivated during a manual calibration, a PC calibration or an automatic Bump Test for the relevant duration.

### Manual implementation without the documentation of results in the instrument memory

- Prepare a test gas cylinder, the volume flow must be 0.5 l/min and the gas concentration must be higher than the alarm threshold concentration to be tested.

Example:

test gas cylinder 68 11 132 = mixed gas with 50 ppm CO, 15 ppm H<sub>2</sub>S, 2 vol. % CO<sub>2</sub>, 2.5 vol. % CH<sub>4</sub>, 18 vol. % O<sub>2</sub>

test gas cylinder 68 11 130 = mixed gas with 50 ppm CO, 15 ppm H<sub>2</sub>S, 2.5 vol. % CH<sub>4</sub>, 18 vol. % O<sub>2</sub>

- Connect the test gas cylinder with the calibration cradle (83 18 752).
- Vent the test gas into a fume cupboard or into the open air (with a hose connected to the second connector of the calibration cradle).

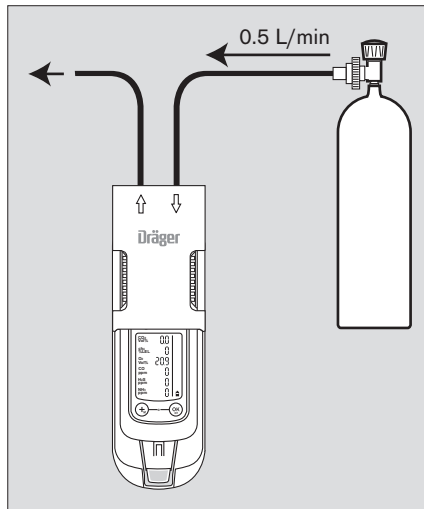

00533072\_01\_en-eps

### CAUTION

Risk to health! Do not inhale the test gas.  
Observe the hazard warnings of the relevant Safety Data Sheets.

- Switch on the instrument and insert it into the calibration cradle – press downwards until it engages.
- Open the test gas cylinder valve to let test gas flow over the sensors.

- Wait until the instrument displays the test gas concentration with sufficient tolerance:  
e. g.  
IR Ex:  $\pm 20\%$  <sup>1)</sup> of test gas concentration  
IR CO<sub>2</sub>:  $\pm 20\%$  <sup>1)</sup> of test gas concentration  
O<sub>2</sub>:  $\pm 0.6$  vol. % <sup>1)</sup>  
TOX:  $\pm 20\%$  <sup>1)</sup> of test gas concentration
- If the alarm thresholds are exceeded, the instrument displays the gas concentration in alternation with » **A1** « or » **A2** « depending on the test gas concentration.
- Close the test gas cylinder valve and remove the instrument from the calibration cradle.
- If the concentration has now fallen under the A1 alarm threshold:
  - Acknowledge the alarm.
  - If the displays are outside of the above-mentioned ranges:
  - Calibrating/adjusting the instrument, refer to Page 48.

<b>NOTICE</b>
---------------

To check the measured value response times, apply t90 test gas to the X-am via the calibration cradle. Check the results in accordance with the information in the table in the enclosed supplementary documentation (order no. 90 33 890) until 90 % of the end display is reached.
--

<b>NOTICE</b>
---------------

After the bump test, the display shows a printer icon even if there is no printer connected to the bump test station.
---

---

1) Upon application of the Dräger mixed gas (order no. 68 11 130) the displays should be within this range.

### Menu implementation with the documentation of results in the instrument memory

The setting whether the bump test is to be carried out manually or automatically is made using the PC software Dräger CC Vision.

The "Quick bump test" or the "Extended bump test" is selected using the Dräger CC Vision PC software.

The "Quick bump test" checks whether the gas concentration has exceeded the Alarm 1 threshold (with oxygen, the check is whether the concentration has fallen below the Alarm 1 threshold).

In the case of the "Extended bump test", a check is made as to whether the gas concentration has reached the set bump test concentration within a tolerance window.  
Setting on delivery: Extended bump test.

- Prepare a test gas cylinder, the volume flow must be 0.5 l/min and the gas concentration must be higher than the alarm threshold concentration to be tested.

Example:

test gas cylinder 68 11 132 = mixed gas with 50 ppm CO, 15 ppm H<sub>2</sub>S, 2 vol. % CO<sub>2</sub>, 2.5 vol. % CH<sub>4</sub>, 18 vol. % O<sub>2</sub>

test gas cylinder 68 11 130 = mixed gas with 50 ppm CO, 15 ppm H<sub>2</sub>S, 2.5 vol. % CH<sub>4</sub>, 18 vol. % O<sub>2</sub>

- Connect the test gas cylinder with the calibration cradle (83 18 752).
- Vent the test gas into a fume cupboard or into the open air (with a hose connected to the second connector of the calibration cradle).

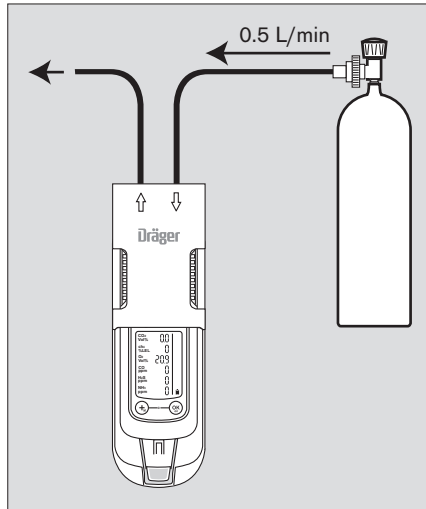

00533072\_01\_en.eps

### ⚠ WARNING

Risk to health! Do not inhale the test gas.  
Observe the hazard warnings of the relevant Safety Data Sheets.

- Switch on the instrument and insert it into the calibration cradle – press downwards until it engages.
- Call the quick menu and select the function test with gas (bump test), Page 17.
- The current gas concentration values and the special symbol » √ ▢ « (for bump test) flash.
- Press the **OK** key to start the function test with gas.
- Open the test gas cylinder valve to let test gas flow over the sensor.
- If gas concentration exceeds the alarm thresholds A 1 or A 2 the corresponding alarm will occur.

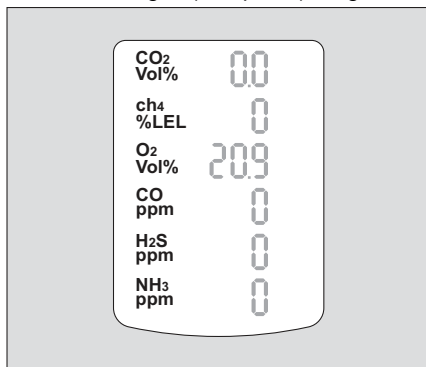

Exit the function test with gas:  
After the preset bump test concentration is reached or a gas alarm is triggered (with the "Quick bump test"):

- The display containing the current gas concentration changes with the display » **OK** «.
- The bump test that was carried out is documented with the result and date in the instrument memory.
- Close the test gas cylinder valve and remove the instrument from the calibration cradle.
- If the concentration values have now fallen under the A1 alarm thresholds, the instrument returns to the measuring mode.
- If the set bump test concentration is not reached within the specified time, the alarm mode is activated to indicate failure.

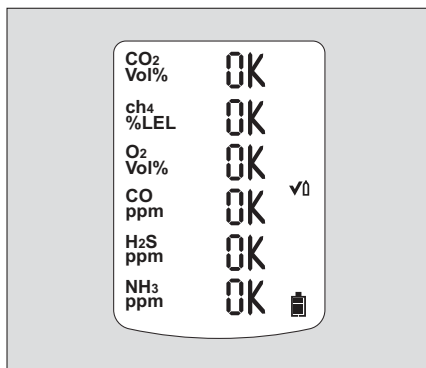

024433072\_01\_en.pdf

02533072\_01\_en.pdf

- The fault message »  « appears and » - - « is displayed instead of the measured value on the faulty measuring channel.
- In this case, repeat the function test with gas or calibrate/adjust the instrument, Page 48.

The function test with gas can also be carried out automatically.  
The "Bump Test Station" is required for this function, refer to Page 46.

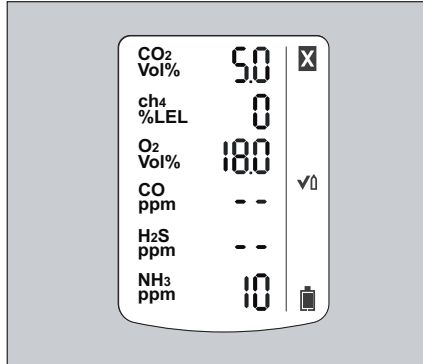

02635072\_01 Lemaps

### Automatic implementation with the Bump Test Station

Prerequisite:

The instrument must first be configured for the automatic function test with gas (bump test) using the PC software Dräger CC Vision.

- Activating the instrument for the automatic function test.
  - Adjust the test gas concentration (mixed gas) with the Dräger CC-Vision PC software if it deviates from the following default values – standard on delivery: 50 ppm CO, 15 ppm H<sub>2</sub>S, 2.5 vol. % CH<sub>4</sub>, 18 vol. % O<sub>2</sub>
  - Define which measuring channels should participate in the automatic function test. All measuring channels participate in the function test by default.
- Prepare the Bump Test Station according to the instructions.
  - Switch on the instrument and insert it into the receptacle of the Bump Test Station until it engages.

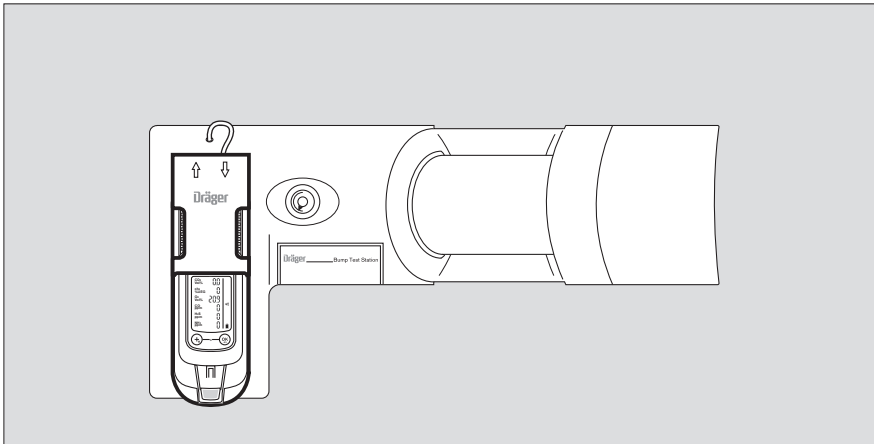

03833072\_01 apps

- The function test with gas is started automatically. The special symbol »  « (for bump test) flashes.

Next:

- If a gas alarm (Quick bump test) is triggered and the preset bump test concentration (Extended bump test) is reached within the specified time, the display shows the current gas concentration, alternating with » OK «.
- Remove the instrument from the Bump Test Station.
- If the concentration values have now fallen under the A1 alarm thresholds, the instrument returns to the measuring mode.

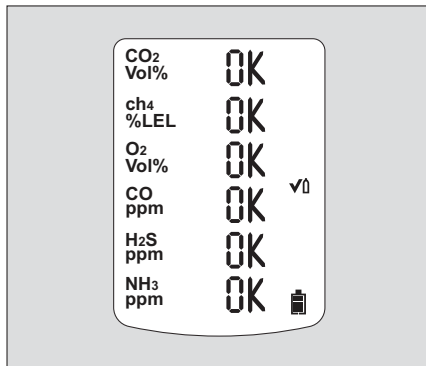

- An error will be triggered if during the function test no alarm occurs and the current measured values do not reach the set target concentration (only extended bump test).
- The fault message » ✖ « appears and » - - « is displayed instead of the measured value on the faulty measuring channel.
- In this case, repeat the function test with gas or calibrate/adjust the instrument, Page 48.

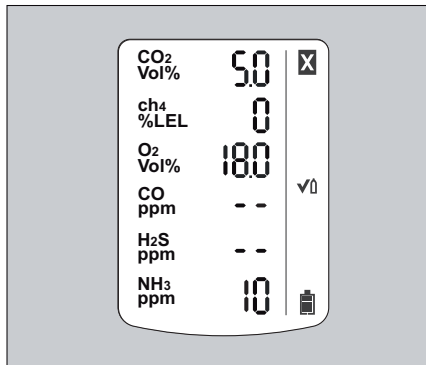

The function test with gas can also be carried out manually, refer to Page 42 and Page 44.

The PC software Dräger CC Vision can be used to enable the "Automatic calibration after incorrect bump test" option.

<b>NOTICE</b>
After the bump test, the display shows a printer icon even if there is no printer connected to the bump gas station.

02533072\_01\_en-eps

02533072\_01\_en-eps

## Calibrating/adjusting the instrument

**NOTICE**

A potentially activated H<sub>2</sub> added signal is automatically temporarily deactivated during a manual calibration, a PC calibration or an automatic Bump Test for the relevant duration.

**NOTICE**

Dräger recommends using the extended bump test for cross calibrations (Dräger X-dock technical manual).

Calibration may not be possible due to instrument and channel errors.

Allow the sensors to warm up before the calibration!

Warm-up time: refer to the Instructions for Use/data sheets of the Dräger Sensors installed.

### Calibration interval:

- Observe the relevant specifications in the Instructions for Use/data sheets of the Dräger Sensors installed.
- For critical applications, observe the recommendations in EN 60079-29-2<sup>1)</sup> or EN 45544-4<sup>2)</sup> and national regulations. We recommend that you calibrate the channels after 6 months.

**⚠ WARNING**

Risk to health! Do not inhale the test gas.

Observe the hazard warnings of the relevant Safety Data Sheets.

- Improve the zero point accuracy – carry out the fresh air calibration/zero-point calibration, Page 49.
- Set the sensitivity of all sensors to the value of the test gas – carry out the 1-button calibration, Page 51.
- Set the sensitivity of a sensor to the value of the test gas – span calibration/ adjustment, Page 54.

1) EN 60079-29-2 – Guidelines for selection, installation, use and maintenance of instruments for the detection and measurement of flammable gases and oxygen.

2) EN 45544-4 – Electrical instruments for the direct detection and direct concentration measurement of toxic gases and vapours – Part 4: Guidelines for selection, installation, use and maintenance.



### Carrying out the fresh air calibration/zero-point calibration

To improve the zero point accuracy, you can carry out a fresh air calibration/zero-point calibration.

#### NOTICE

If the sensors are configured such that no sensor allows fresh-air adjustment (e.g. O<sub>3</sub> only, CO<sub>2</sub> channel of the infrared sensor only), the fresh-air adjustment menu function is not offered.

- Calibrate the instrument to fresh air calibration/zero-point calibration, free of measured gases or other interfering gases.
- All sensors are included in the fresh air calibration/zero-point calibration.<sup>1)</sup> Sensors which have not warmed up or which are faulty prevent a calibration/adjustment.  
In the case of sensors which are in the warm-up phase, the message » 159 « is displayed with the special symbol » ☐ « (for warning message).  
In the case of a sensor or instrument error, the message » 109 « is displayed with the special symbol » ☒ « (for a fault message).  
The message is cleared after 5 sec. and the function is available again in the menu.
- During the fresh-gas adjustment/zero-point adjustment, the zero point of all sensors (with the exception of the DrägerSensor XXS O<sub>2</sub>, CO<sub>2</sub> channel of the infrared sensor) is set to 0.  
In the case of the DrägerSensor XXS O<sub>2</sub>, the display is set to 20.9 vol.-%.
- Switch on the instrument.

Depending on instrument configuration:

- Call the quick menu and select the Fresh Air Calibration/zero-point calibration function, Page 17.  
or
- Call the calibration menu and select the Fresh Air Calibration /zero-point calibration function, Page 19.
- The current gas concentration values flash.

When the measured values have stabilized:

- Press the  key to perform the fresh air calibration/zero-point calibration.

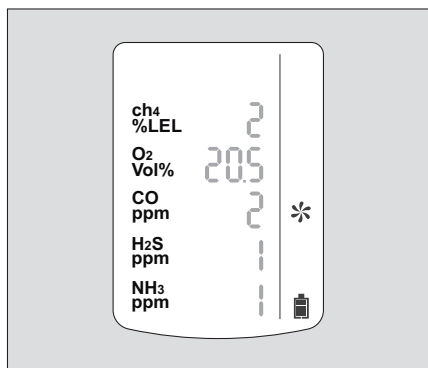

03133072\_01\_enepps

1) The fresh-gas adjustment/zero-point adjustment is not supported by the CO<sub>2</sub> channel of the infrared sensor and the XXS O<sub>3</sub>. A zero-point calibration / adjustment of these sensors can be conducted using the Dräger CC Vision software. To do so, a suitable zero gas that is free of carbon dioxide and ozone (e.g. N<sub>2</sub>) should be used.

- The display containing the current gas concentration changes with the display » OK «.
- Press the **OK** key to confirm the calibration/adjustment or wait for approx. 5 seconds.

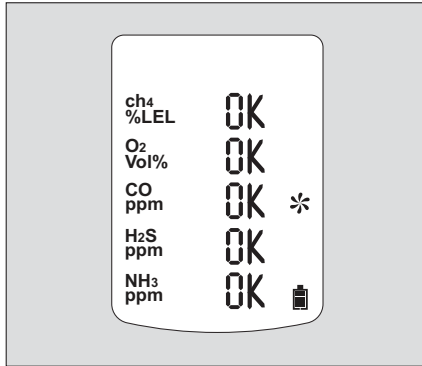

03233072\_01\_en-eps

If a fault occurred during the fresh air calibration/zero-point calibration:

- The fault message » **X** « appears and » - - « is displayed for the respective sensor instead of the measured value.
- In this case, repeat the fresh air calibration/zero-point calibration.

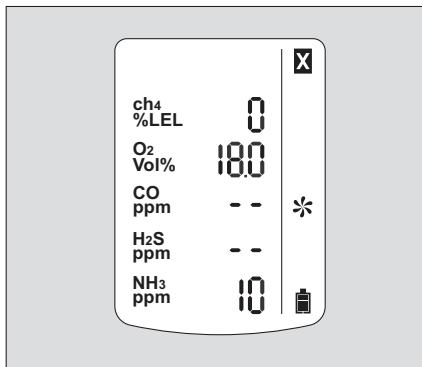

03233072\_01\_en-eps

**NOTICE**

**Automatic surrogate calibration**

If the corresponding gas combination and the sensor are approved to do so, an automatic surrogate calibration and tests can be performed using the PC software Dräger CC-Vision<sup>1)</sup>.

A gas for the bump test, for the adjustment and the measured gas can be set in the gas change wizard in Dräger CC-Vision.

Conversions are performed automatically and no longer need to be made manually. The settings are also used by the Dräger X-dock.

1) The free of charge PC software Dräger CC-Vision can be downloaded from the following web address: [www.draeger.com/software](http://www.draeger.com/software)

## Carrying out 1-button calibration/adjustment

### NOTICE

If no sensors are approved for the 1-button adjustment via the PC software Dräger CC-Vision, the 1-button adjustment menu function will not be available.

- All the sensors which can be calibrated/adjusted are included in the 1-button calibration.

- In the case of the 1-button calibration, the sensitivity of all sensors is set to the value of the test gas.

When using the test gas cylinder:

68 11 132 = mixed gas with  
50 ppm CO, 15 ppm H<sub>2</sub>S,  
2 vol. % CO<sub>2</sub>, 2.5 vol.-% CH<sub>4</sub>,  
18 vol. % O<sub>2</sub>.

- When using the test gas cylinder:  
68 11 130 = mixed gas with 50 ppm  
CO, 15 ppm H<sub>2</sub>S, 2.5 vol. % CH<sub>4</sub>,  
18 vol. % O<sub>2</sub>

If a mixed gas with another composition is used, the specified concentration values in the instrument must be changed to the target values of the mixed gas used using the PC software Dräger CC Vision.

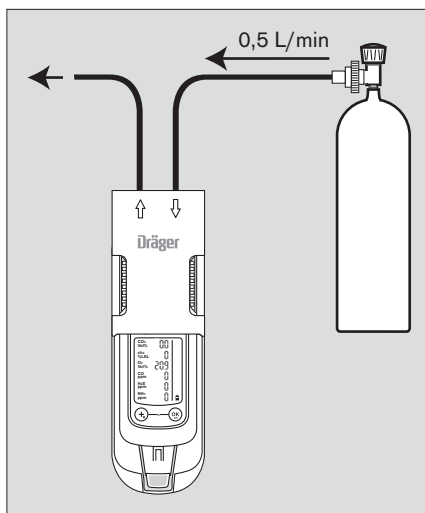

- Connect the test gas cylinder with the calibration cradle.
- Vent the test gas into a fume cupboard or into the open air (with a hose connected to the second connector of the calibration cradle).

### ⚠ WARNING

Risk to health!

Do not inhale the test gas.

Observe the hazard warnings of the relevant Safety Data Sheets.

- Switch on the instrument and insert it into the calibration cradle until it engages.
- Call the calibration menu, enter the password and select the 1-button calibration/adjustment function, Page 19.
- Press the **OK** key to start the 1-button calibration/adjustment.

- Open the test gas cylinder valve to let test gas flow over the sensor.
  - The currently displayed measured values start to flash.
  - The flashing stops after a static measured value has been reached.
  - The calibration/adjustment is now carried out automatically.
  - The displayed measured values change to the values according to the gas supplied.
  - The automatic stability monitoring can be overridden by pressing the **OK** key. A calibration then takes place immediately. If it is detected that no test gas has been applied, the 1-button calibration will be aborted. The channels will then indicate » **n/a** «. If only one sensor is taking part in the 1-button calibration, a calibration will be performed in each case when the **OK** key is pressed.

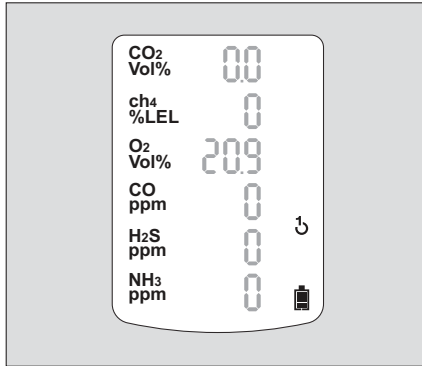

When the calibration/adjustment is completed and the displayed measured values have stabilized:

- The display containing the current gas concentration changes with the display » **OK** «.
- Press the **OK** key or wait for 5 seconds to quit the calibration/adjustment.
- The instrument changes to the measuring mode
- Close the test gas cylinder valve and remove the instrument from the calibration cradle.

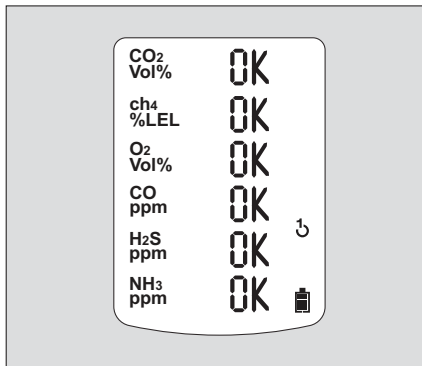

If a fault occurred during the 1-button calibration/adjustment.

- The fault message »  « appears and » - - « is displayed for the respective sensor instead of the measured value.
- In this case, repeat the 1-button calibration/adjustment or carry out a single gas calibration/adjustment, refer to Page 54.
- If necessary, replace the sensor, Page 63.

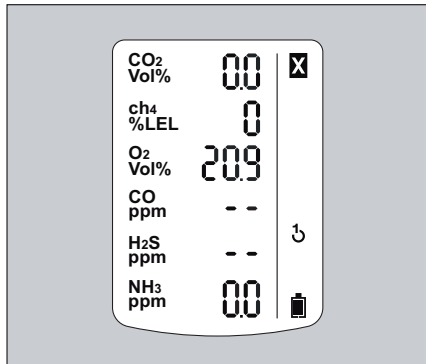

030039072\_01\_en.pdf

**Calibrating/adjusting the sensitivity for an individual measuring channel**

- The span calibration/adjustment can be carried out specifically for individual sensors.
  - In the case of the span calibration/adjustment, the sensitivity of the selected sensor is set to the value of the test gas used.
  - Use a standard test gas.
- Allowed test gas concentration:

Ex channel of the infrared sensor	20 to 100 %LEL <sup>1)2)</sup> / 5 to 100 <sup>1)2)</sup> vol. %
CO <sub>2</sub> channel of the infrared sensor	0.05 to 5 vol.-% <sup>2)</sup>
O <sub>2</sub>	10 to 25 vol.-%
CO:	20 to 999 ppm
H <sub>2</sub> S:	5 to 99 ppm
H <sub>2</sub> HC	0,5 to 4,0 vol.-%
NO <sub>2</sub>	5 to 99 ppm
Test gas concentration of other gases: see Instructions for Use for the respective Dräger sensors.	

- Connect the test gas cylinder with the calibration cradle.
- Vent the test gas into a fume cupboard or into the open air (with a hose connected to the second connector of the calibration cradle).

**⚠ WARNING**

Risk to health!  
Do not inhale the test gas.  
Observe the hazard warnings of the relevant Safety Data Sheets.

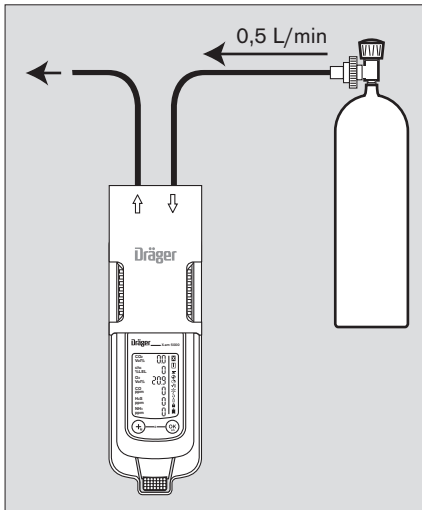

1) Depending on the selected data set.  
2) Depending on the measuring range and the measuring accuracy.

- Switch on the instrument and insert it into the calibration cradle.
  - Press the **+** key and keep it pressed for 5 seconds to call the calibration menu.
  - Enter the password with the **+** key and confirm with the **OK** key.
  - Use the **+** button to select the single gas calibration/adjustment function and confirm with the **OK** button.
- The display flashes the gas of the first measuring channel, e.g. »  $\text{CH}_4$  %LEL « (see example 1, Page 56).

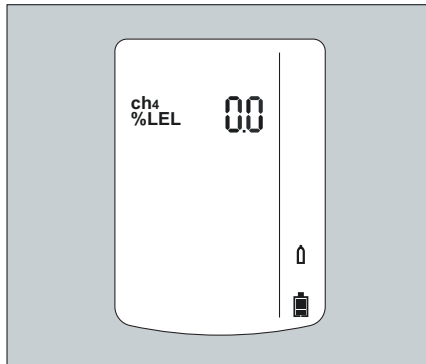

03533072\_01\_en.rpp

**NOTICE**

The  $\text{CO}_2$  channel accepts a special setting during the calibration routine, since the calibration menu can also be used to adjust the zero point (see example 2, Page 57).

- Press the **OK** key to carry out the calibration/adjustment of this measuring channel, or use the **+** key to select another measuring channel (e. g.  $\text{O}_2$  vol. %,  $\text{H}_2\text{S}$  - ppm,  $\text{CO}$  - ppm or another toxic sensor).

There are two examples for the calibration of individual measuring channels below.

### Example 1: Span calibration for the Ex channel of the infrared sensor

- Press the **OK** key to carry out the calibration/adjustment of the selected measuring channel.
  - The calibration gas concentration is displayed
- Press the **OK** key to confirm the calibration gas concentration or use the **+** key to change the calibration gas concentration and complete the process by pressing the **OK** key.
  - The measurement value flashes.
- Open the test gas cylinder valve to let test gas flow over the sensor.
  - The displayed, flashing measurement value changes to the value according to the supplied test gas.

When the displayed measurement value has stabilized:

- Press the **OK** key to carry out the calibration.
  - The display containing the current gas concentration changes with the display » **OK** «.
- Press the **OK** key or wait for approx. 5 seconds to quit the calibration/adjustment of this measuring channel.
  - The next measuring channel appears for calibration.
  - After the calibration/adjustment of the last measuring channel, the instrument changes to the measuring mode.

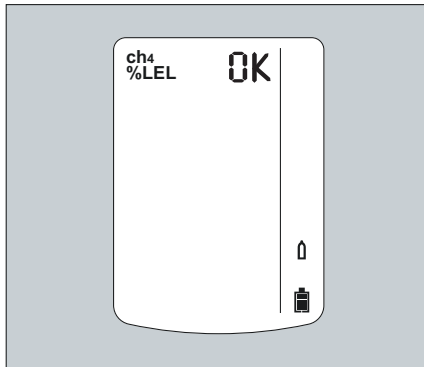

03733072\_01\_en.pdf

- Close the test gas cylinder valve and remove the instrument from the calibration cradle.

If a fault occurred during the span calibration.

- The fault message » **✖** « appears and » - - « is displayed for the respective sensor instead of the measured value.
- In this case, repeat the calibration/adjustment.
- If necessary, replace the sensor, Page 63.

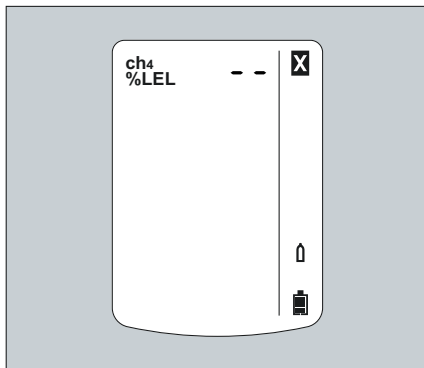

03733072\_01\_en.pdf



**Example 2: Calibration routine for the CO<sub>2</sub> channel of the infrared sensor**

- Select » **CO<sub>2</sub> vol.-%** « as measuring channel and confirm with **OK** key.
- The display shows » **100 vol% N2** « flashing.

Zero-point calibration:

- Press **OK** key to implement the zero-point calibration or use the **+** key to select the span calibration.
- The calibration gas concentration is displayed.
- Press **OK** key to confirm the calibration gas concentration 100 vol. % N2 (cannot be changed).
- The measurement value flashes.
- Open the test gas cylinder valve to let test gas flow over the sensor.
- The displayed, flashing measurement value changes to the value according to the supplied test gas.

When the displayed measurement value has stabilized:

- Press the **OK** key to carry out the calibration.
- The display containing the current gas concentration changes with the display » **OK** «.
- Press the **OK** key or wait for approx. 5 seconds to quit the zero-point calibration of this measuring channel.
- The display changes automatically to span calibration.
- Close the test gas cylinder valve and remove the instrument from the calibration cradle or, if necessary, change to test gas for the span calibration.
- » **xx Vol% CO2** « flashes.

Span calibration:

- Press the **OK** key to carry out the span calibration or press the **+** key for the span calibration for the next measuring channel.
- The calibration gas concentration is displayed.
- Press the **OK** key to confirm the calibration gas concentration or use the **+** key to change the calibration gas concentration and complete by pressing the **OK** key.
- The measurement value flashes.
- Open the test gas cylinder valve to let test gas flow over the sensor.
- The displayed, flashing measurement value changes to the value according to the supplied test gas.

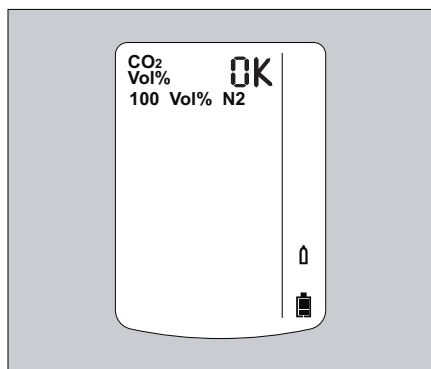

061135072\_01\_de.pdf

When the displayed measurement value has stabilized:

- Press the **OK** key to carry out the calibration.
- The display containing the current gas concentration changes with the display » **OK** «.
- Press the **OK** key or wait for approx. 5 seconds to quit the calibration/adjustment of this measuring channel.
- The next measuring channel appears for calibration.
- After the calibration/adjustment of the last measuring channel, the instrument changes to the measuring mode.

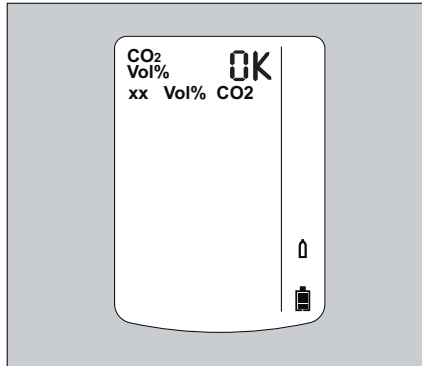

0633072\_01\_dfraps

- Close the test gas cylinder valve and remove the instrument from the calibration cradle.

If a fault occurred during the span calibration.

- The fault message » **✖** « appears and » - - « is displayed for the respective sensor instead of the measured value.
- In this case, repeat the calibration/adjustment.
- If necessary, replace the sensor, Page 63.

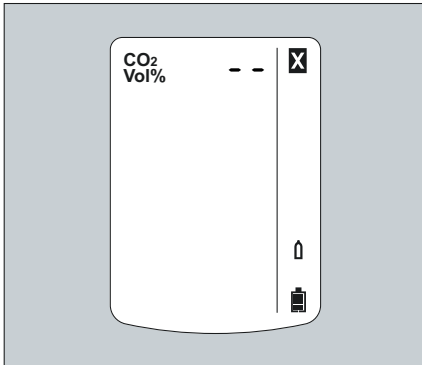

0633072\_01\_dfraps

## Replacing the batteries / rechargeable batteries

### ⚠ WARNING

Explosion hazard! To reduce the risk of flammable or explosive atmospheres igniting, it is essential that the warning notices below are observed:

Do not throw used batteries into fire or try to open them by force.

Do not replace or charge batteries in areas at risk of an explosion hazard.

Do not mix new batteries with used batteries, and do not mix batteries from different manufacturers or of different types.

Remove batteries before maintenance work.

Batteries / rechargeable batteries are part of the Ex approval. Only the following types may be used:

- Alkaline batteries – T3 – (not rechargeable!)
  - Panasonic LR6 Powerline
  - Varta Type 4106<sup>1)</sup> (power one) oder
  - Varta Type 4006<sup>1)</sup>(industrial)
- Alkaline batteries – T4 – (not rechargeable!)
  - Duracell Procell MN1500<sup>1)</sup>, Duracell Plus Power MN1500<sup>1)</sup>
- NiMH rechargeable batteries – T3 – (rechargeable)
  - GP 180AAHC<sup>1)</sup> (1800) max. 40 °C ambient temperature.

1) Not subject to BVS10 ATEX E 080X and PFG 10 G 001X performance approval.

Switching off the instrument:

- Press and hold the **OK** key and the **+** key at the same time.

**1** Loosen the screw (2.0 mm hexagon socket) on the power pack and remove the power pack.

**2a** For the battery holder (order no. 83 22 237):

### ⚠ WARNING

Danger of explosion!

The Dräger X-am 5600 must only be operated with battery holder ABT 0100 (X-am 5600), identified with a silver sticker.

- Replace alkaline batteries or NiMH rechargeable batteries. Ensure correct polarity.

**2b** Completely replace the power pack T4/T4 HC (with sealed rechargeable batteries, order no. 83 18 704/83 22 244).

- Insert the power pack into the instrument and tighten the screw, the instrument switches on automatically.

After replacing the power pack T4/T4 HC, it is recommended that a complete charging is carried out.

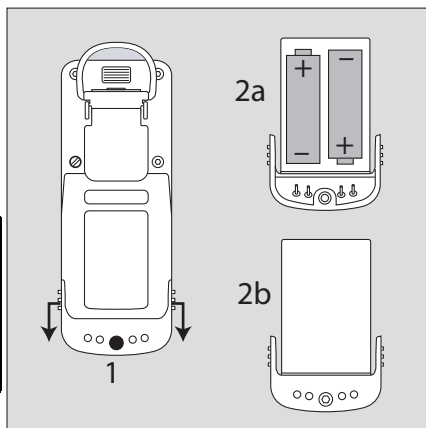

**After the batteries have been replaced:**

- The settings and data are stored when the battery is replaced. The sensors warm up again.

## Charging the rechargeable batteries

 **WARNING**

Explosion hazard! To reduce the risk of flammable or explosive atmospheres igniting, it is essential that the warning notices below are observed:

Do not charge underground or in explosion-hazard areas! Danger of explosion!

The chargers are not designed in accordance with the regulations for firedamp and explosion protection.

Charge the type HBT 0000 or HBT 0100 power pack using the relevant Dräger charger. Charge NiMH rechargeable batteries for battery holder ABT 0100 in accordance with the manufacturer's specifications. Ambient temperature during the charge process: 0 to +40 °C. See marking on power pack for approved batteries and related temperature class.

Even if the instrument is not used, we recommend that you store the instrument in the charger (Charging module X-am 1/2/5000, order no. 83 18 639)!

To maintain the lifetime of the batteries, charging is temperature controlled and only performed in a temperature range of 5 to 35 °C.

When this temperature range is left, the charging process is automatically interrupted and automatically continued after the temperature range has been reached again.

The charging time is typically 4 hours.

A new NiMH power pack reaches its full capacity after three complete charging/ discharging cycles. Never store the instrument for extended periods without being connected to a power source (maximum of 2 months) because the internal buffer battery will drain.

### Charging with the multiple charging station

- On the power supply unit (order no. 83 21 850 with adapter 83 25 736), a maximum of 20 instruments can be charged at the same time.
- When attaching the charging modules, disconnect the power pack from the mains supply!

### Attaching charging modules (exemplary presentation)

- 1 Turn the slots of the interlock into a horizontal position by using a screwdriver or coin.
- 2 Insert the projecting tongue of the charging module (at the same time, current entry) until it engages.
- 1 Close the interlock with a quarter turn (slot is positioned vertically).

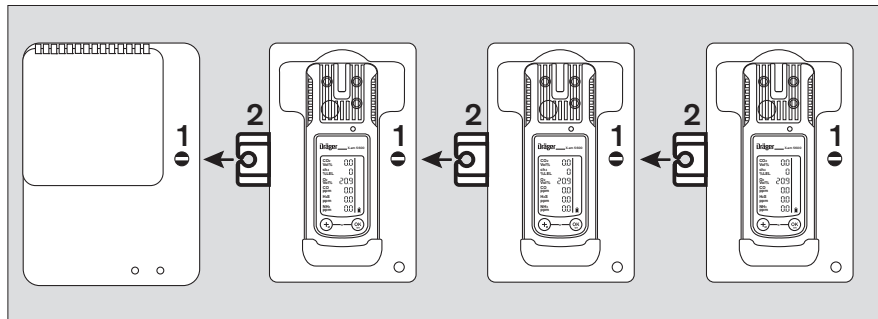

00733072\_01\_en.eps

- Attach additional charging modules in the same way.
- Always connect or disconnect the charging modules individually and not in groups in order to prevent the charging station from becoming damaged. During transportation, the power pack and the charging modules should also always be handled individually and without inserted instruments.

- Position the instrument on an even and level surface.

- Connecting the power pack to the mains.

- 1 The green "Mains" LED lights.
- Insert the instrument into the charging module.

- 2 Display LED on the charger:

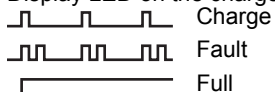

If a fault occurs:  
 Remove the instrument from the charging module and insert it again.  
 If the fault still occurs, have the charging module repaired.

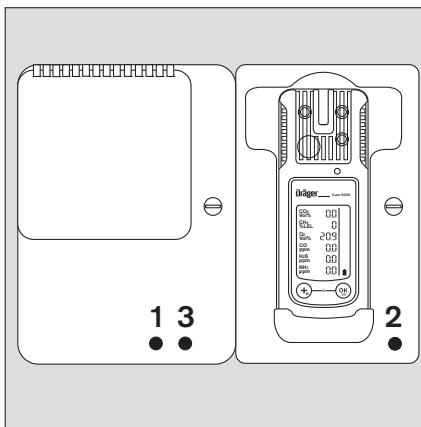

00833072\_01\_en.eps

It takes approx. 4 hours to fully charge an empty rechargeable battery.

A short circuit of the charging contacts in the charging modules, e.g., by metallic objects that have fallen in, does not result in damage to the charging station. It should, however, be avoided due to possible heating hazards and incorrect displays on the charging module.

In the event of a short circuit or if the power pack is overloaded:

- 3 The red "Overload" LED lights, and an audible alarm sounds.
- After the fault has been corrected, the alarm is switched off automatically and the charging process is restarted.
- In the event of a power failure, the instruments already charged will be protected from discharging.

### Charging with charging module and plug-in power pack or vehicle charging adapter

- When using the power pack (order no. 83 16 994), up to 5 instruments can be charged at the same time, with power pack (order no. 83 15 635) up to 2 instruments.
- The power pack contained in the rechargeable battery and charging set (order no. 83 18 785) is suitable for charging an instrument.
- When using the vehicle charging adapter (order no. 83 17 754) it is recommended that you supply every charging module separately.

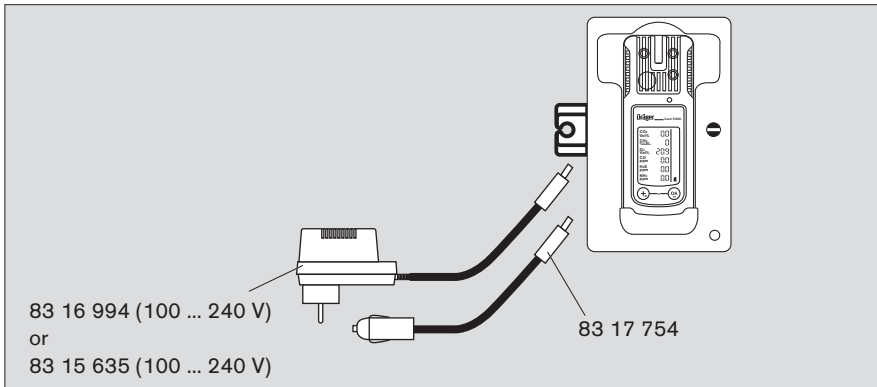

The charging process is carried out analogue to charging with the multiple charging station.

## Replacing the Sensors

### CAUTION

#### ⚠ Damage to components!

There are components in the instrument that are sensitive to electric charge. Before opening the instrument to replace the sensor, ensure that the person performing the work is earthed to avoid damage to the device. Earthing can be safely ensured, e. g. via an ESD workstation (electrostatic discharge).

### NOTICE

To open the instrument, unfasten the casing screws using a screwdriver (Torx T6).

- To replace the sensors of the instrument, connect the instrument with a PC.
- Replace the sensors using the PC program Dräger CC Vision.
- With every sensor change of the Ex and/or CO<sub>2</sub> infrared sensors, the form ring above and the foam mat underneath the sensor must also be replaced if permanent deformation is detected.

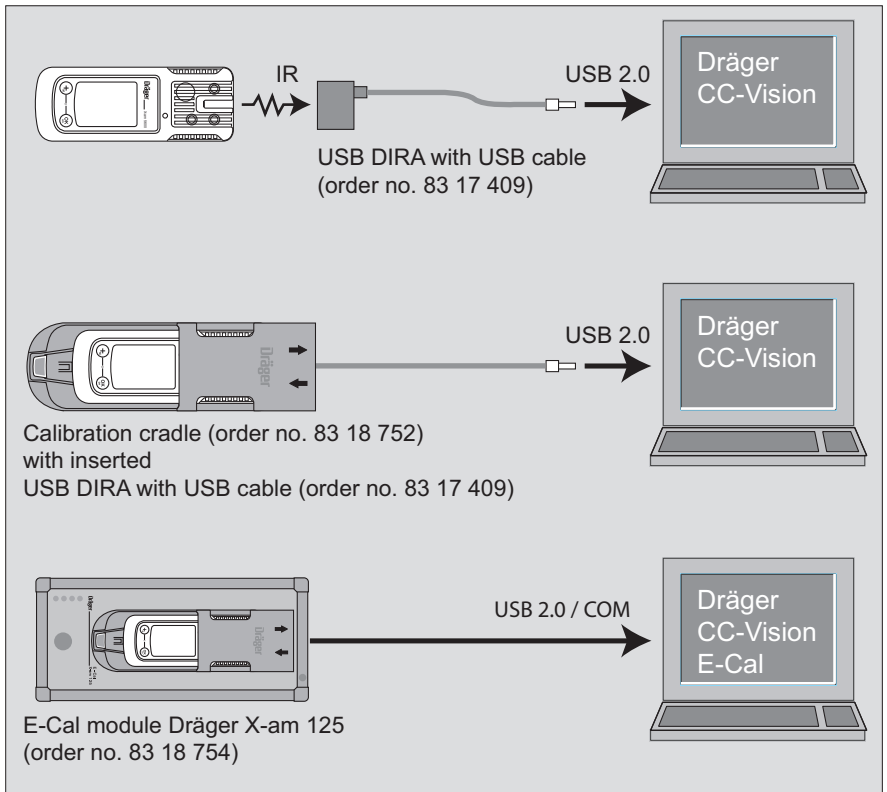

Next:

- Carry out a fresh air calibration/zero-point calibration, Page 49.
- and then:
- Calibrate/adjust the sensitivity:
    - either
    - carry out 1-button calibration/adjustment, Page 51
    - or
    - calibrate/adjust the sensitivity, Page 54.

### Disposing of electrochemical sensors

#### WARNING

Do not throw into fire,  
Do not force open. Acid burn risk!  
Sensors of type XXS O<sub>3</sub> and XXS NO<sub>2</sub> LC contain small quantities of nanomaterials.



Like batteries, only dispose of as special waste, in accordance with local waste disposal regulations. Further information can be obtained from the relevant local authority and from appropriate waste disposal companies.

### Disposing of infrared sensors

The Ex and or CO<sub>2</sub> infrared sensors must be disposed of as electronic waste.



In accordance with EU Directive 2002/96/EC, this product must not be disposed of as household waste. This is indicated by with the adjacent icon. You can return this product to Dräger free of charge. For information please contact the national marketing organisations and Dräger.



## Cleaning

The instrument does not need any special care.

- Dirt and deposits can be removed from the instrument by washing it with cold water. A sponge can be used for wiping if necessary.

<b>NOTICE</b>
Abrasive cleaning implements (brushes etc.), cleaning agents and cleaning solvents can destroy the dust and water filters.

- Carefully dab dry the instrument using a cloth.

## Storage

- Dräger recommends storing the instrument in the charger module (order no. 83 18 639).
- Dräger recommends checking the charge of the power supply at least every three weeks if the instrument is not stored in the charger module.

## Disposal



This product must not be disposed of as municipal waste. This is indicated by the adjacent icon. You can return this product to Dräger free of charge. For information please contact the national sales organisations and Dräger.



Batteries and rechargeable batteries must not be disposed of as municipal waste. This is indicated by the adjacent icon. Collect and dispose of batteries and rechargeable batteries at battery collection centres, in accordance with applicable regulations.

## Technical Data

<b>Ambient conditions:</b>	
during operation and storage	<p>Temperature class T4 (–20 to +50 °C):                      NiMH power packs type: HBT 0000, HBT 0100                      Power pack type: ABT 0100                      with alkaline single cell type:                      Duracell Procell MN 1500<sup>1)</sup>,                      Duracell Plus Power MN 1500<sup>1)</sup></p> <p>Temperature class T3 (–20 to +40 °C):                      Power pack type: ABT 0100                      with NiMH single cell type: GP 180AAHC<sup>1)</sup>                      with alkaline single cell type:                      Panasonic LR6 Powerline</p> <p>Temperature class T3 (0 to +40 °C):                      Power pack type: ABT 0100                      with alkaline single cell type: Varta 4006<sup>1)</sup>,                      Varta 4106<sup>1)</sup></p>
Temperature range over a short period (ATEX & IECEx only) <sup>1)</sup> :	<p>–40 to +50 °C                      Maximum of 15 minutes with NiMH power pack T4 (HBT 0000) or T4 HC (HBT 0100)                      Prerequisite: storage of the instrument at room temperature (+20 °C) for at least 60 minutes in advance.</p>
Air pressure	700 to 1300 hPa
Humidity	10 to 90 % (up to 95 % short-term) rel. hum.
Storage time	
X-am 5600	1 year
Sensors	1 year

<b>Instrument data</b>	
Position of use	any
Protection class	IP 67 for instruments with sensors
Alarm volume	Typically 90 dB (A) in 30 cm distance
Operation time	
– Alkaline battery/NiMHy rechargeable batteries (battery holder ABT 0100 (X-am 5600))	Typically 9 hours under normal conditions
– NiMH rechargeable batteries	
T4 (HBT 0000)	Typically 9 hours under normal conditions when using Dual IR Ex/CO <sub>2</sub>
	Typically 12 hours under normal conditions when using Dual IR Ex/CO <sub>2</sub> ES
T4 HC (HBT 0100)	Typically 10,5 hours under normal conditions
Dimensions	approx. 130 mm x 48 mm x 44 mm (H x W x D)
Weight	approx. 220 g to 250 g
Refresh interval for display and signals	1 s

1) Not part of the BVS 10 ATEX E 080 X and PFG 10 G 001 X technical suitability tests.

## Order List

Name and description	Order no.
<p><b>Dräger X-am 5600</b>            Unlimited multi gas detector for 1 to 6 gases with replaceable sensors.</p> <p>Dräger X-am 5600 ATEX, IECEX            With selectable special calibration.            With default alarm thresholds that can be adjusted specifically for each country.</p> <p>Dräger X-am 5600 Basic ATEX, IECEX</p> <p>Dräger X-am 5600 Basic CSA C US</p>	<p></p> <p><b>83 21 050</b></p> <p><b>83 21 373</b></p> <p><b>83 22 930</b></p>
<p><b>Power supply units:</b></p> <p>NiMH power pack T4</p> <p>NiMH power pack HBT 0100 T4 HC (X-am 5600)</p> <p>Battery holder ABT 0100 (X-am 5600), <sup>1)</sup>            (without alkaline batteries)</p> <p>Alkaline batteries T3 (2x) <sup>1)</sup></p> <p>Alkaline batteries T4 (2x) <sup>1)</sup></p> <p>Battery and charger set (includes NiMH power pack T4, charger module for Dräger X-am 1/2/5000 and plug-in power supply unit)</p> <p>HC battery and charger set (X-am 5600)            (includes NiMH power pack HBT 0100 T4 HC, charger module for Dräger X-am 1/2/5000 and plug-in power supply unit)</p>	<p><b>83 18 704</b></p> <p><b>83 22 244</b></p> <p><b>83 22 237</b></p> <p><b>83 22 239</b></p> <p><b>83 22 240</b></p> <p><b>83 18 785</b></p> <p><b>83 22 785</b></p>
<p><b>Chargers:</b></p> <p>Charging adapter for Dräger X-am 1/2/5000</p> <p>Charger module for Dräger X-am 1/2/5000</p> <p>Plug-in power supply unit, 100–240 VAC; 6.25 A            for charging up to 20 instruments</p> <p>required adapter for 83 21 850</p> <p>Plug-in power supply unit (worldwide)            for max. 5 Dräger X-am 1/2/5000 charger modules</p> <p>Vehicle connection, 12 V/24 V            for Dräger X-am 1/2/5000 charger module</p> <p>Vehicle mount            for 1 Dräger X-am 1/2/5000 charger module</p>	<p><b>83 26 101</b></p> <p><b>83 18 639</b></p> <p><b>83 21 850</b></p> <p><b>83 25 736</b></p> <p><b>83 16 994</b></p> <p><b>45 30 057</b></p> <p><b>83 18 779</b></p>

1) Not part of the BVS10 ATEX E 080X and PFG 10 G 001X technical suitability test.

Name and description	Order no.
<p><b>Accessories</b></p> <p>The accessories are not part of BVS10 ATEX E 080X and PFG 10 G 001X technical suitability tests.</p>	
<p><b>Pump accessories:</b></p> <p>Dräger X-am Pump</p> <p>Case for Dräger X-am Pump</p> <p>USB power supply unit (for Dräger X-am Pump)</p> <p>USB cable (for Dräger X-am Pump)</p> <p>Rubber ball pump</p> <p>Manual pump adapter</p> <p>Filter set for X-am 1/2/5000</p>	<p><b>83 27 100</b></p> <p><b>83 27 104</b></p> <p><b>83 27 102</b></p> <p><b>83 24 992</b></p> <p><b>68 01 933</b></p> <p><b>83 19 195</b></p> <p><b>83 19 364</b></p>
<p><b>Extension hoses and probes (excerpt):</b></p> <p>Measuring probe<sup>1)</sup>, 0.5 m</p> <p>Measuring probe<sup>1)</sup>, 1.5 m</p> <p>Telescopic probe<sup>1)</sup>, plug-in</p> <p>Telescopic probe<sup>1)</sup> 100 with accessories</p> <p>Telescopic probe<sup>1)</sup> 150 stainless steel</p> <p>Bar probe<sup>1)</sup> 90</p> <p>Floating probe with accessories (transparent)</p> <p>Fluoroelastomer hose (5 mm), sold by the metre, specify length when ordering</p> <p>Hose (not suitable for H<sub>2</sub>S) CR-NR (rubber, 5 mm), sold by the metre, specify length when ordering</p> <p>3 mm tube connection set<sup>2)</sup></p> <p>5 mm tube connection set</p> <p>Floating probe (3 mm), EPP, 3 m hose<sup>2)</sup></p> <p>Floating probe (3 mm), EPP, 10 m hose<sup>2)</sup></p> <p>Fluoroelastomer hose (3 mm) incl. adapter, 5 m<sup>2)</sup></p> <p>Fluoroelastomer hose (3 mm) incl. adapter, 10 m<sup>2)</sup></p> <p>Fluoroelastomer hose (3 mm) incl. adapter, 20 m<sup>2)</sup></p> <p>Fluoroelastomer hose<sup>3)</sup> (3 mm), sold by the metre, specify length when ordering</p> <p>Hose (3 mm), PVC, sold by the metre, specify length when ordering</p>	<p><b>64 08 238</b></p> <p><b>64 08 239</b></p> <p><b>68 01 954</b></p> <p><b>83 16 530</b></p> <p><b>83 16 533</b></p> <p><b>83 16 532</b></p> <p><b>83 18 371</b></p> <p><b>12 03 150</b></p> <p><b>11 80 681</b></p> <p><b>83 27 641</b></p> <p><b>83 27 642</b></p> <p><b>83 25 831</b></p> <p><b>83 25 832</b></p> <p><b>83 25 705</b></p> <p><b>83 25 706</b></p> <p><b>83 25 707</b></p> <p><b>83 25 837</b></p> <p><b>83 25 838</b></p>

Name and description	Order no.
Hose (rubber, 3 mm), CR-NR, sold by the metre, specify length when ordering	<b>83 25 839</b>
<p><b>Accessories for recording the measured values and for configuration:</b></p> <p>Dräger CC-Vision (free full version available at <a href="http://www.draeger.com/software">www.draeger.com/software</a>)</p> <p>Dräger GasVision licence key (to upgrade from trial version to full version)</p> <p>USB DIRA with USB cable (USB infrared adapter for communication between Dräger X-am 1/2/5000 and PC)</p>	<p><b>83 25 646</b></p> <p><b>83 17 409</b></p>
<p><b>Calibration accessories:</b></p> <p>Dräger X-dock, e.g. X-dock 5300 X-am 125</p> <p>Bump test station, incl. mixed-gas cylinder</p> <p>Calibration cradle for Dräger X-am 1/2/5000</p> <p>Mixed-gas cylinder 15 ppm H<sub>2</sub>S, 50 ppm CO, 2.5 vol.% CH<sub>4</sub>, 18 vol.% O<sub>2</sub></p> <p>Mixed-gas cylinder 15 ppm H<sub>2</sub>S, 50 ppm CO, 2 vol.% CO<sub>2</sub>, 2.5 vol.% CH<sub>4</sub>, 18 vol.% O<sub>2</sub></p> <p>Test gas cylinder, propane, 0.9 vol.% C<sub>3</sub>H<sub>8</sub> in air</p> <p>Test gas cylinder, hydrogen, 2 vol.% H<sub>2</sub> in air</p> <p>On-demand controller</p> <p>Standard controller</p>	<p><b>83 21 880</b></p> <p><b>83 19 130</b></p> <p><b>83 18 752</b></p> <p><b>68 11 130</b></p> <p><b>68 11 132</b></p> <p><b>68 11 118</b></p> <p><b>68 10 388</b></p> <p><b>83 16 556</b></p> <p><b>68 10 397</b></p>
<p><b>Other accessories:</b></p> <p>Protective sleeve for Dräger X-am 1/2/5X00</p> <p>Carrying bag</p>	<p><b>83 21 506</b></p> <p><b>83 18 755</b></p>

Name and description	Order no.
<b>Spare parts</b>	
DrägerSensor DUAL IR Ex/CO <sub>2</sub>	<b>68 11 960</b>
DrägerSensor IR Ex	<b>68 12 180</b>
DrägerSensor IR CO <sub>2</sub>	<b>68 12 190</b>
DrägerSensor Dual IR Ex/CO <sub>2</sub> ES	<b>68 51 880</b>
DrägerSensor Dual IR Ex ES	<b>68 51 881</b>
DrägerSensor Dual IR CO <sub>2</sub> ES	<b>68 51 882</b>
DrägerSensor XXS O <sub>2</sub> , 0 to 25 vol.% <sup>4)</sup>	<b>68 10 881</b>
DrägerSensor XXS O <sub>2</sub> 100, 0 to 100 vol.%	<b>68 12 385</b>
DrägerSensor XXS CO, 0 to 2000 ppm <sup>5)</sup>	<b>68 10 882</b>
DrägerSensor XXS H <sub>2</sub> S, 0 to 200 ppm <sup>2)</sup>	<b>68 10 883</b>
DrägerSensor XXS NO <sub>2</sub> , 0 to 500 ppm <sup>2)</sup>	<b>68 10 884</b>
DrägerSensor XXS SO <sub>2</sub> , 0 to 100 ppm <sup>2)</sup>	<b>68 10 885</b>
DrägerSensor XXS CO-LC, 0 to 2000 ppm <sup>2)</sup>	<b>68 13 210</b>
Other DrägerSensors	<b>upon request <sup>6)</sup></b>

- 1) The filter set for X-am 1/2/5000 (order no. 83 19 364) includes a 5 mm tube connection set to connect the probe to the pump.
- 2) This accessory is optimised for the Dräger X-am Pump (market launch in 2017) (for hoses with 3 mm inner diameter).
- 3) 3 mm tube connection set (order no. 83 27 641) required.
- 4) Expected sensor life time: O<sub>2</sub>, CO and H<sub>2</sub>S >5 years.
- 5) Not part of the BVS10 ATEX E 080X and PFG 10 G 001X technical suitability test.
- 6) Data sheets for all sensors that may be used with the device can be downloaded from the product page of the X-am 5600 on the following website: [www.draeger.com](http://www.draeger.com).

**Dräger Safety AG & Co. KGaA**

Revalstraße 1

D-23560 Lübeck

Germany

Phone +49 451 8 82- 0

Fax +49 451 8 82- 20 80

[www.draeger.com](http://www.draeger.com)

**90 33 072** - TH 4638.220 en  
© Dräger Safety AG & Co. KGaA  
Edition 15 - September 2019  
(Edition 01 - September 2009)  
Subject to alteration